

TECHNICAL MANUAL

**ORGANIZATIONAL, DIRECT SUPPORT, AND GENERAL SUPPORT MAINTENANCE
REPAIR PARTS AND SPECIAL TOOLS LISTS
(INCLUDING DEPOT MAINTENANCE REPAIR PARTS AND SPECIAL TOOLS)**

FOR

MULTIMETERS

ME-26A/U (NSN 6625-00-360-2493)

ME-26B/U (NSN 6625-00-646-9409)

ME-26C/U (NSN 6625-00-646-9409)

AND

ME-26D/U (NSN 6625-00-913-9781)

**H E A D Q U A R T E R S , D E P A R T M E N T O F T H E A R M Y
AUGUST 1978**

TECHNICAL MANUAL }
No. 11-6625-200-24P }

HEADQUARTERS
DEPARTMENT OF THE ARMY
WASHINGTON, DC, 4 August 1978

**ORGANIZATIONAL, DIRECT SUPPORT, AND GENERAL SUPPORT MAINTENANCE
REPAIR PARTS AND SPECIAL TOOLS LISTS
(INCLUDING DEPOT MAINTENANCE REPAIR PARTS AND SPECIAL TOOLS)
FOR
MULTIMETERS
ME-26A/U (NSN 6625-00360-2493)
ME-26B/U (NSN 6625-00-649409)
ME-26C/U (NSN 6625-006469409)
AND
ME-26D/U (NSN 6625-00-913-9781)
*Current as of 18 January 1978***

REPORTING OF ERRORS

You can improve this manual by recommending improvements using DA Form 2028-2 located in the back of the manual. Simply tear out the self addressed form, fill it out as shown on the sample, fold it where shown, and drop it in the mail.

If there are no blank DA Form 2028-2 in the back of your manual, use the standard DA Form 2028 (Recommended Changes to Publications and Blank Forms) and forward to the Commander, US Army Communications and Electronics Materiel Readiness Command, ATTN: DRSEL-MA-Q, Fort Monmouth, New Jersey 07703.

In either case a reply will be furnished direct to you.

Table of Contents

			Page	Illus.
			Figure	
SECTION	I.	Introduction -----	1	
	II.	Repair parts list -----	5	
Group	00.	Multimeters ME-26A/U, ME-26B/U, ME-26C/U, and ME-26D/U -----	5	1-16
SECTION	III.	Special tools list (Not applicable)		
	IV.	National stock number and part number index -----	36	

***This manual supersedes TM 11-625-200-24P, 17 September 1973.**

SECTION I INTRODUCTION

1. Scope

This manual lists spares and repair parts; special tools; special test, measurement, and diagnostic equipment (TMDE), and other special support equipment required for performance of original, direct support, and general support maintenance of the ME-26A/U, ME-26B/U, ME-26C/U, and ME-26D/U. It authorizes the requisitioning and issue of spares and repair parts as indicated by the source and maintenance codes.

2. General

This Repair Parts and Special Tools List is divided into the following sections:

a. Section II. Repair Parts List. A list of spares and repair parts authorized for use in the performance of maintenance. The list also includes parts which must be removed for replacement of the authorized parts. Parts lists are composed of functional groups in numeric sequence, with the parts in each group listed in figure and item number sequence.

b. Section III. Special Tools List. Not applicable.

c. Section IV. National Stock Number and Part Number Index. A list, in National item identification number (NIIN) sequence, of all National stock numbers (NSN) appearing in the listings, followed by a list, in alphanumeric sequence, of all part numbers appearing in the listings. National stock numbers and part numbers are cross-referenced to each illustration figure and item number appearance.

3. Explanation of Columns

a. Illustration. This column is divided as follows:

(1) *Figure number.* Indicates the figure number of the illustration on which the item is shown.

(2) *Item number.* The number used to identify item called out in the illustration.

b. Source, Maintenance, and Recoverability (SMR) Codes.

(1) *Source code.* Source codes indicate the manner of acquiring support items for maintenance

repair, or overhaul of end items. Source codes are entered in the first and second positions of the Uniform SMR Code format as follows:

<i>Code</i>	<i>Definition</i>
-------------	-------------------

PA	-Item procured and stocked for anticipated or known usage.
----	--

XD	-A support item that is not stocked. When required, item will be procured through normal supply channels.
----	---

NOTE

Cannibalization or salvage may be used as a source of supply for any items source coded above except those coded XA and aircraft support items as restricted by AR 700-42.

(2) *Maintenance code.* Maintenance codes are assigned to indicate the levels of maintenance authorized to USE and REPAIR support items. The maintenance codes are entered in the third and fourth positions of the Uniform SMR Code format as follows:

(a) The maintenance code entered in the third position will indicate the lowest maintenance level authorized to remove, replace, and use the support item. The maintenance code entered in the third position will indicate one of the following levels of maintenance:

<i>Code</i>	<i>Application/Explanation</i>
-------------	--------------------------------

O-	Support item is removed, replaced, used at the organizational level.
----	--

H-	Support item is removed, replaced, used at the general support level.
----	---

(b) The maintenance code entered in the fourth position indicates whether the item is to be repaired and identifies the lowest maintenance level with the capability to perform complete repair (i.e., all authorized maintenance functions). This position will contain one of the following maintenance codes:

<i>Code</i>	<i>Application/Explanation</i>
-------------	--------------------------------

Z-	Nonreparable. No repair is authorized.
----	--

(3) *Recoverability code.* Recoverability codes are assigned to support items to indicate the disposition action on unserviceable items. The recoverability code is entered in the fifth position of the Uniform SMR Code format as follows:

Recoverability codes

Definition

Z- Nonreparable item. When unserviceable, condemn and dispose at the level indicated in position 3.

c. *National Stock Number.* Indicates the National stock number assigned to the item and will be used for requisitioning purposes.

d. *Part Number.* Indicates the primary number used by the manufacturer (individual, company, firm, corporation, or Government activity), which controls the design and characteristics of the item by means of its engineering drawings, specifications, standards, and inspection requirements to identify an item or range of items.

NOTE

When a stock numbered item is requisitioned, the repair part received may have a different part number than the part being replaced.

e. *Federal Supply Code for Manufacturer (FSCM).* The FSCM is a 5-digit numeric code listed in SB 708-42 which is used to identify the manufacturer, distributor, or Government agency, etc.

f. *Description.* Indicates the Federal item name and, if required, a minimum description to identify the item.

g. *Unit of Measure (U/M).* Indicates the standard of the basic quantity of the listed item as used in performing the actual maintenance function. This measure is expressed by a two-character alphabetical abbreviation (e.g., ea, in, pr, etc). When the unit of measure differs from the unit of issue, the lowest unit of issue that will satisfy the required units of measure will be requisitioned.

h. *Quantity Incorporated in Unit.* Indicates the quantity of the item used in the breakout shown on the illustration figure, which is prepared for a

functional group, subfunctional group, or an assembly.

4. Special Information

a. Usable on codes are shown in the description column. Uncoded items are applicable to all models. Identification of the usable on codes used in this publication are:

<i>Code</i>	<i>Used on</i>
AE2	ME-26A/U
AE3	ME-26B/U
AE4	ME-26C/U
AXL	ME-26D-U

b. The following publication pertains to the ME-26A/U, ME-26B/U, ME-26C/U, and ME-26/U and their components: TM 11-6625-200-15, Multimeters ME-26A/U, ME-26B/U, ME-26C/U, and ME-26D/U

5. How to Locate Repair Parts

a. When National stock number or part number is unknown.

(1) *First.* Using the table of contents, determine the functional group within which the item belongs. This is necessary since illustrations are prepared for functional groups and listings are divided into the same groups.

(2) *Second.* Find the illustration covering the functional group to which the item belongs.

(3) *Third.* Identify the item on the illustration and note the illustration figure and item number of the item.

(4) *Fourth.* Using the Repair Parts Listing, find the figure and item number noted on the illustration.

b. When National stock number or part number is known.

(1) *First.* Using the Index of National Stock Numbers and Part Numbers, find the pertinent National stock number or part number. This index is in NIIN sequence followed by a list of part numbers in alphanumeric sequence, cross-referenced to the illustration figure number and item number.

(2) *Second.* After finding the figure and item number, locate the figure and item number in the repair parts list.

6. Abbreviations

Not applicable.

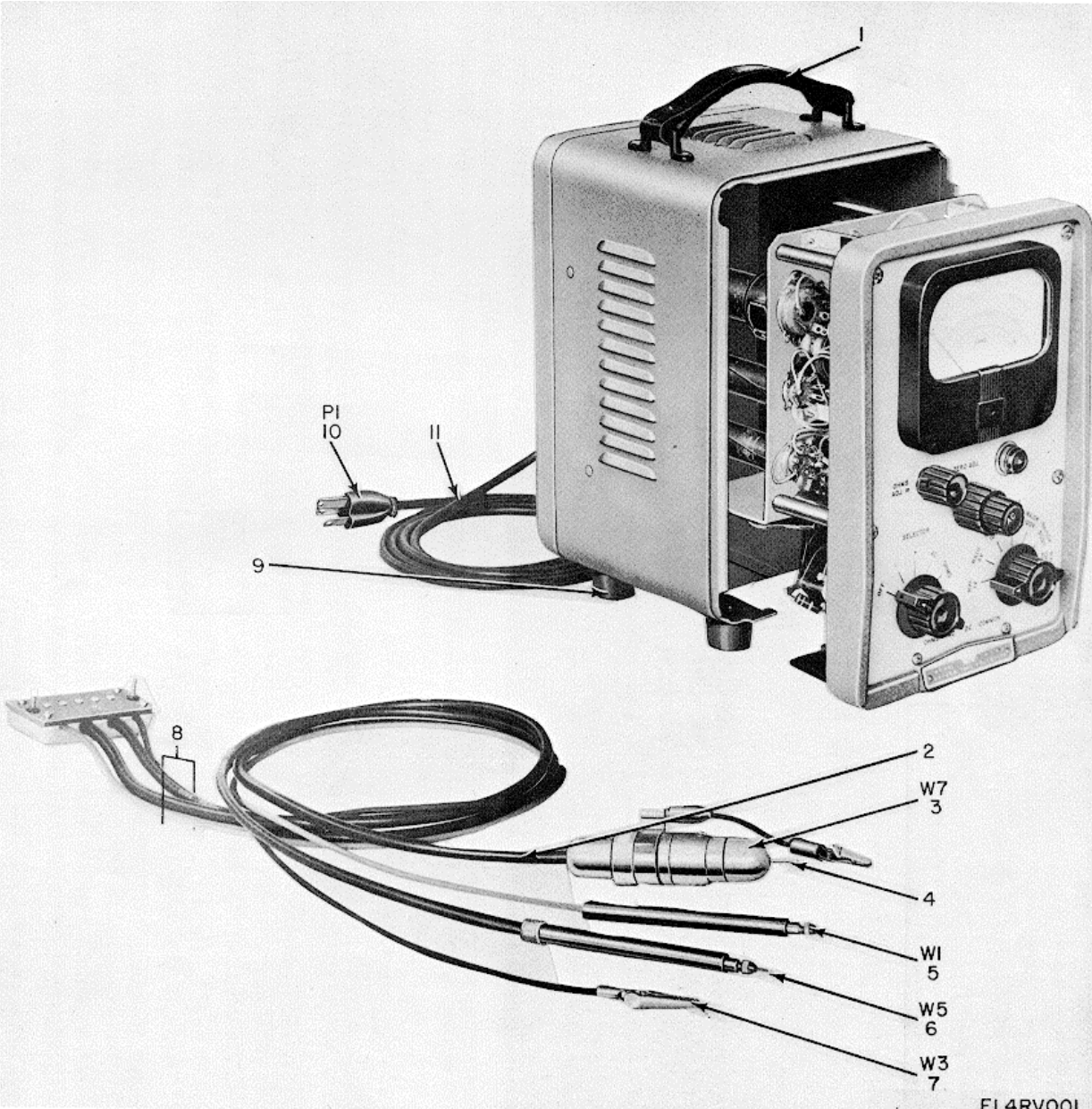

EL4RV001

Figure 1. ME-26A/U Multimeter.

SECTION II

TM11-6625-200-24P

(1) ILLUSTRATION		(2)	(3)	(4)	(5)	(6) DESCRIPTION	(7)	(8)
(a) FIG NO.	(b) ITEM NO.	SMR CODE	NATIONAL STOCK NUMBER	PART NUMBER	FSCM	<i>USABLE ON CODE</i>	U/M	QTY INC IN UNIT
						GROUP 00 ME-26A, B, C.D/U MULTIMETERS		
1	1	XDHZZ		1440-0002	00837	HANDLE, LUGGAGE	AE2 EA	1
1	2	PAHZZ	6145-00-635-9338	8410	70903	CABLE, RF	AE2 FT	4
1	3	PAHZZ	6625-00-898-7270	SCM339386	80063	LEAD, TEST	AE2 EA	1
1	4	XDHZZ		6580202Y2K	72982	PLUG, TIP	AE2 EA	3
1	5	PAHZZ	662S-00-821-2307	410821-95D	28480	LEAD, TEST	AE2 EA	1
1	6	PAHZZ	6625-00-068-1739	410821-95C	28480	LEAD, TEST	AE2 EA	1
1	7	PAHZZ	6625-00-825-6704	410821-95E	28480	LEAD, TEST	AE2 EA	1
1	8	PAHZZ	6625-00-302-4909	410821-95A	28480	LEAD SET, TEST	AE2 EA	1
1	9	PAHZZ	5340-00-846-8451	0403-0004	28480	BUMPER, RUBBER	AE2 EA	4
1	10	PAHZZ	5935-00-636-7145	UP121M	81349	CONNECTION, PLUG, ELEC	AE2 EA	1
1	11	PAHZZ	6145-00-284-0579	C003MGF3-18-0330	81349	CABLE, PWR, ELEC	AE2 FT	7

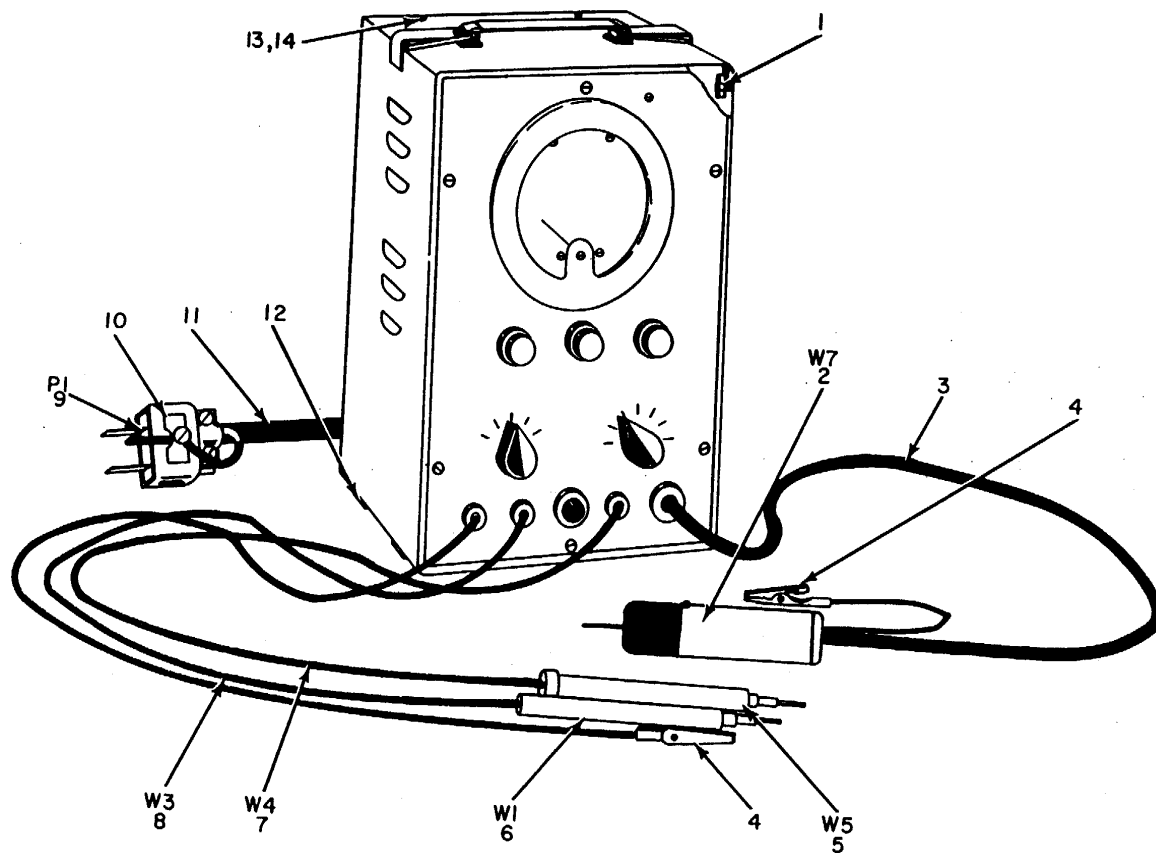

Figure 2. ME-26B, C, D/U Multimeters.

EL4RV002

SECTION II

TM11-6625-200-24P

(1) ILLUSTRATION		(2)	(3)	(4)	(5)	(6) DESCRIPTION		(7)	(8)
(a) FIG NO.	(b) ITEM NO.	SMR CODE	NATIONAL STOCK NUMBER	PART NUMBER	FSCM	USABLE ON CODE		U/M	QTY INC IN UNIT
2	1	PAHZZ	5325-00-285-2012	A3-25	72794	STUD, TIUNLOCK.FSTNR	AE3.AE4.AXL	EA	4
2	2	PAHZZ	6625-00-898-7270	SMC339386	80063	LEAD, TEST	AE3.AE4.AXL	EA	1
2	3	PAHZZ	6145-00-583-9268	RG122U	81349	CABLE, RF	AE3, AE4, AXL	FT	4
2	4	PAHZZ	5999-00-204-5206	60	76545	CLIP, ELECTRICAL	AE3.AE4, AXL	EA	2
2	5	PAHZZ	6625-00-618-1766	81619	70902	LEAD, TEST	AE3, AE4, AXL	I EA	1
2	6	PAHZZ	6625-00-331-1471	319	83330	LEAD, TEST	AE3.AE4.AXL	EA	1
2	7	PAHZZ	6145-00-229-9862	8899BLACK	10903	WIRE, ELECTRICAL	AE3, AE4, AXL	FT	4
2	8	PAHZZ	6L45-00-249-8781	8899RED	70903	WIRE, ELECTIRICAL	AE3, AE4, AXL	FT	4
2	9	PAHZZ	5935-00-636-7145	UP21M	81349	CONNECTOR, PLUG, ELEC	AE3, AE4, AXL	EA	1
2	10	PAHZZ	6250-00-845-8390	81246	72619	ADAPTER	AE3.AE4, AXL	EA	1
2	11	PAHZZ	6145-00-284-0579	C003GF3-18-0330	81349	CABLE, PNR, ELEC	AE3.AE4, AXL	FT	7
2	12	PAHZZ	5340-00-846-8451	0403-0004	28480	BUMPER, RUBBER	AE3.AE4, AXL	EA	4
2	13	PAHZZ	5325-00-275-4480	GA3-200	72794	EYELET, TRNLK, FSTNR	AE3, AE4.AXL	EA	4
2	14	PAHZZ	5325-00-171-4680	S3-175	72794	LOCKSPRING.TRNLK	AE3.AE4.AXL	EA	4

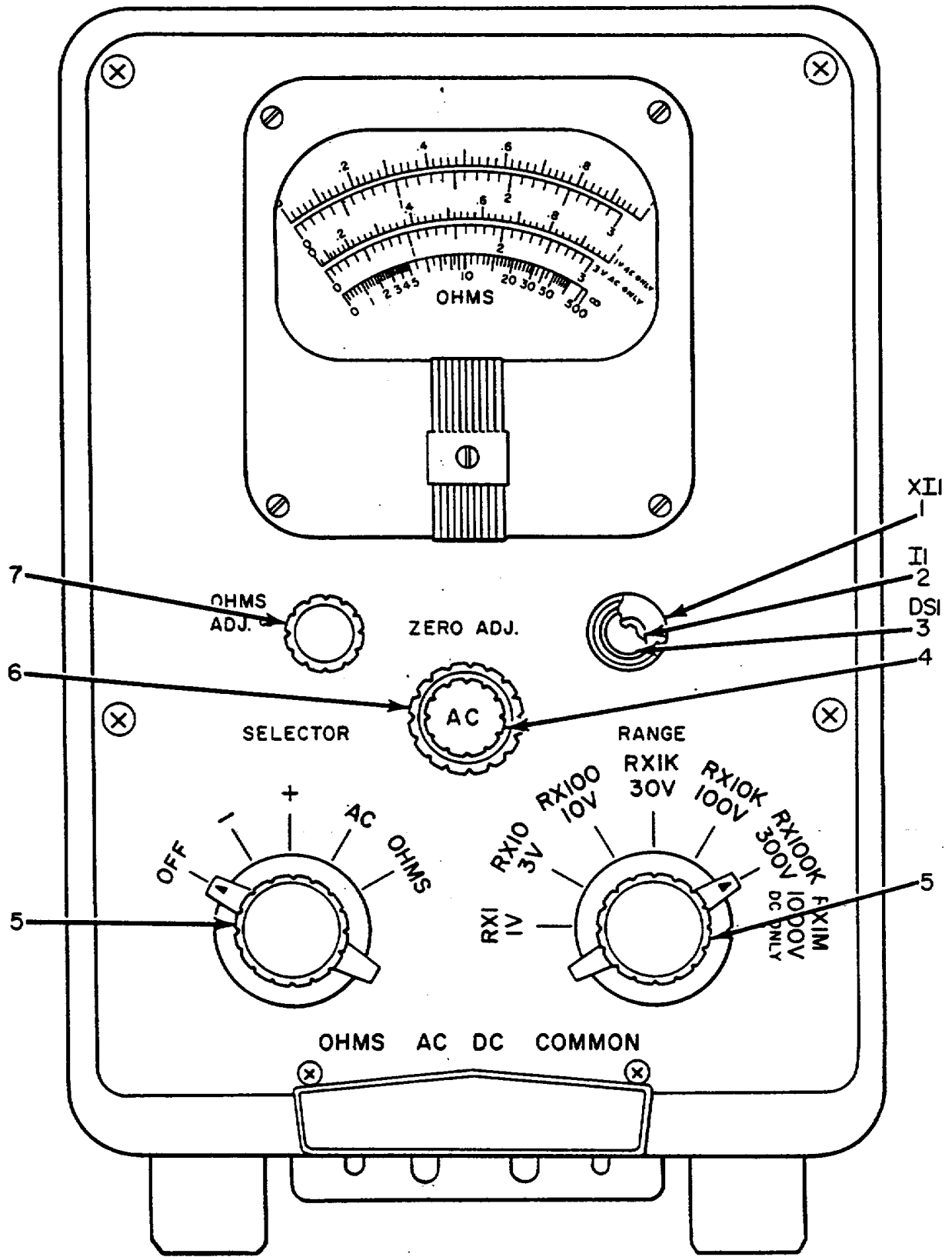

EL4RV003

Figure 3. ME-26A/U Multimeter, Front Panel.

SECTION II

TM11-6625-200-24P

(1) ILLUSTRATION		(2)	(3)	(4)	(5)	(6)	(7)	(8)
(a) FIG NO.	(b) ITEM NO.	SMR CODE	NATIONAL STOCK NUMBER	PART NUMBER	FSCM	DESCRIPTION <i>USABLE ON CODE</i>	U/M	QTY INC IN UNIT
3	1	PAHZZ	6210-00-299-4099	81081	72619	LAMPHOLDER AE2	EA	1
3	2	POZZ	6240-00-155-8706	47	24446	LAMP, INCANDESCENT AE2	EA	1
3	3	PAOZZ	6210-00-188-8779	81-121	72619	LENS, IND LIGIHT AE2	EA	1
3	4	PAOZZ	5355-00-801-0470	G74AC	28480	KNOB AE2	EA	1
3	5	PAOZZ	5355-00-547-7996	G74N	28480	KNOB AE2	EA	2
3	6	PAOZZ	5355-00-803-4286	G74J	28480	KNOB AE2	EA	1
3	7	PAOZZ	5355-00-721-8924	G74C	28480	KNOB AE2	EA	1

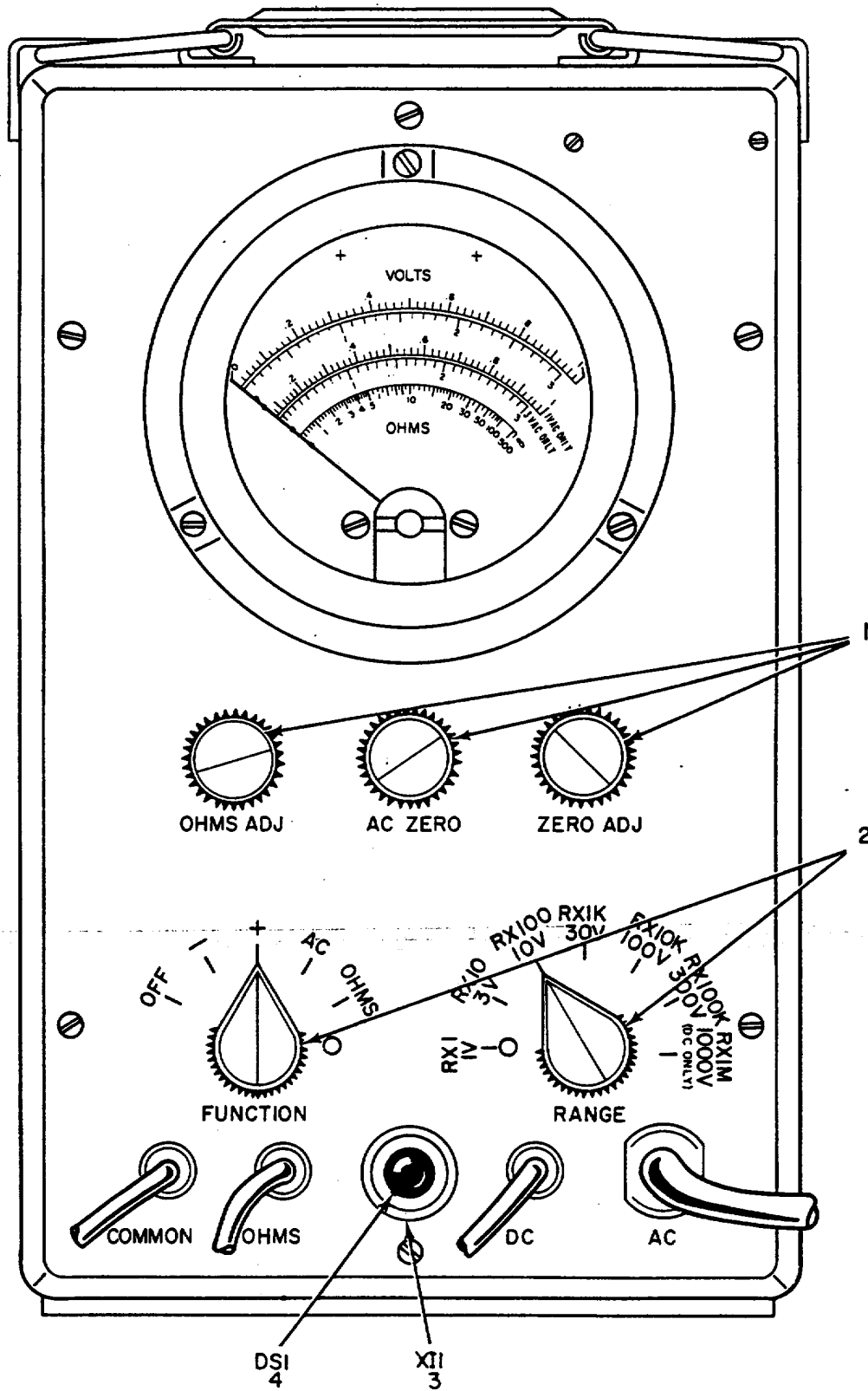

EL4RV004

Figure 4. ME-26B, C, D/U Multimeters, Front Panel.

SECTION II

TM11-6625-200-24P

(1) ILLUSTRATION		(2)	(3)	(4)	(5)	(6) DESCRIPTION		(7)	(8)
(a) FIG NO.	(b) ITEM NO.	SMR CODE	NATIONAL STOCK NUMBER	PART NUMBER	FSCM	<i>USABLE ON CODE</i>		U/M	QTY INC IN UNIT
4	1	PAOLZ	5355-00-543-0789	MS91528-1N2D	96906	KNOB	AE3, AE4, AXL	EA	3
4	2	PAOZZ	5355-00-556-0145	MS91528-1K2D	96906	KNOB	AE3, AE4, AXL	EA	2
4	3	PAHZZ	6210-00-299-4099	810B1	72619	LAMPHOLDER	AE3, AE4, AXL	EA	1
4	4	XDHZZ		LH50BR2	81349	LIGHT, INDICATOR	AE3, AE4, AXL	EA	1

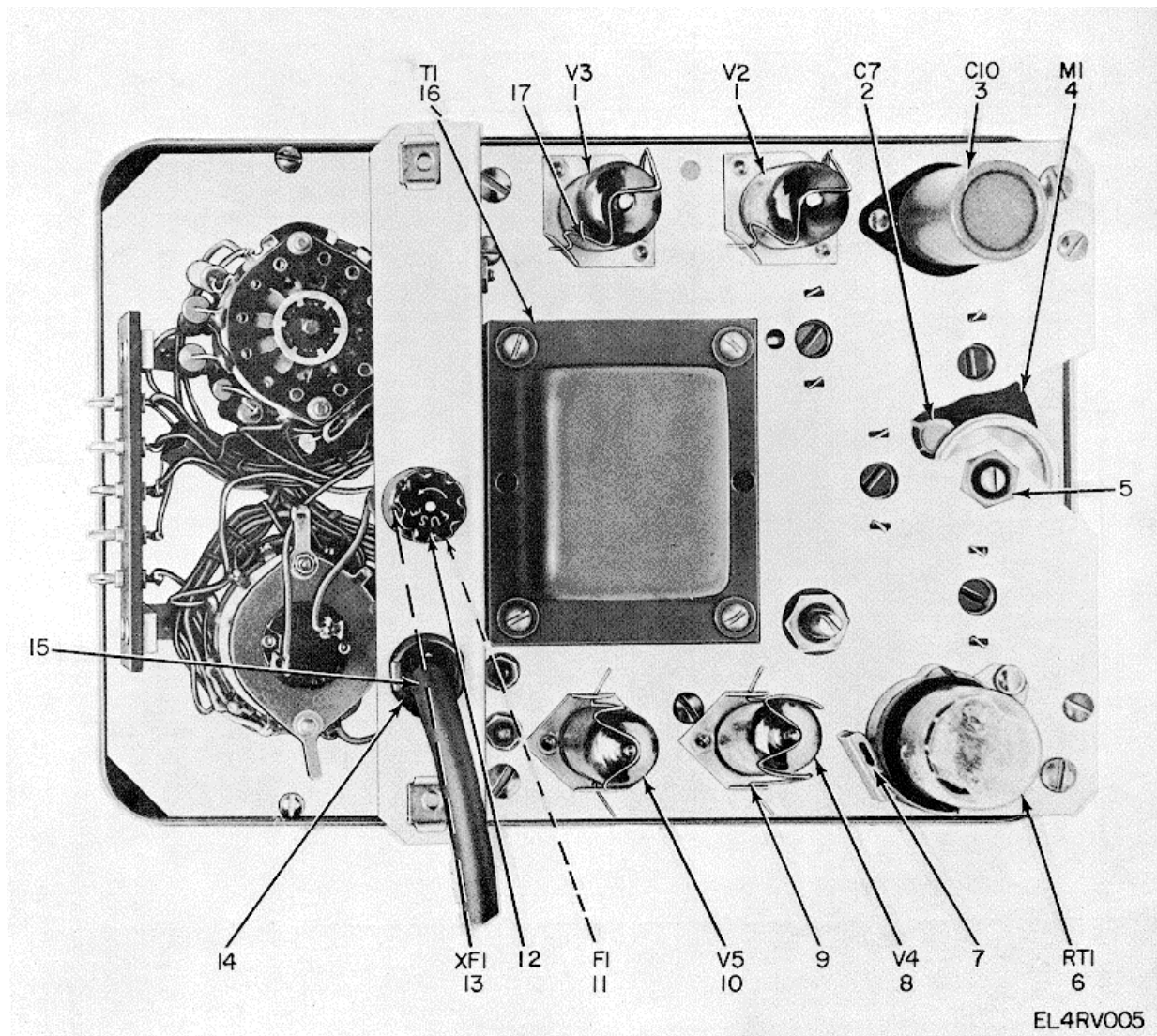

EL4RV005

Figure 5. ME-26A/U Multimeter, Chassis, Rear View.

SECTION II

TM11-6625-200-24P

(1) ILLUSTRATION		(2)	(3)	(4)	(5)	(6) DESCRIPTION	(7)	(8)
(a) FIG NO.	(b) ITEM NO.	SMR CODE	NATIONAL STOCK NUMBER	PART NUMBER	FSCM	<i>USABLE ON CODE</i>	U/M	QTY INC IN UNIT
5	1	PAHZZ	5960-00-636-2218	6189-12AU7	81349	ELECTRON TUBE AE2	EA	2
5	2	PAHZZ	5910-00-722-1552	DD472	71590	CAPACITOR, FXD, CER AE2	EA	1
5	3	PAHZZ	5910-00-816-4176	028434	56289	CAPACITOR, ELCTLT AE2	EA	1
5	4	PAHZZ	6625-00-649-4958	1120-0009	28480	MULTIMETER, REPLMENT AE2	EA	1
5	5	PAHZZ	5935-00-845-1376	410B21K	28480	NUT, BUSHING, RTNR AE2	EA	1
5	6	PAHZZ	5905-00-258-0794	6-4	70563	RESISTOR, CUR, RGLT AE2	EA	1
5	7	PAHZZ	5960-00-715-0179	1200D-63AHS	91506	RETAINER.TUBE AE2	EA	1
5	8	PAHZZ	5960-00-624-4718	0B2WA	81349	ELECTRON TUBE AE2	EA	1
5	9	PAHZZ	5340-00-844-3170	1400-0039	25480	RETAINER, TUBE AE2	EA	2
5	10	PAHZZ	5969-00-272-9182	6X4WA	81349	ELECTRON, TUBE AE2	EA	1
5	11	PAOZZ	5920-00-503-2882	313-400	75915	FUSE, CARTRIDGE, SEL AE2	EA	1
5	11	PAOZZ	5920-00-504-8634	313-250	75915	FUSE, CARTRIDGE, SEL AE2	EA	L
5	12	PAOZZ	5999-00-244-5150	9435-1-2	71400	CAP, ELECTRICAL AE2	EA	L
5	13	PAHZZ	5920-00-892-9311	FHN27U	81349	FUSEHOLDER AE2	EA	1
5	14	PAHZZ	5975-00-273-0788	6P1	28520	BUSHES, STRAIN RLF AE2	EA	1
5	15	PAHZZ	5325-00-846-8452	500	01538	GROMMET, RUBBER AE2	EA	1
5	16	PAHZZ	5950-00-950-0524	9100-0021	28480	TRANSFORMER, SDN, SU AE2	EA	1
5	17	PAHZZ	5960-00-284-6893	1400-0005	28480	RETAINER, TUBE AE2	EA	2

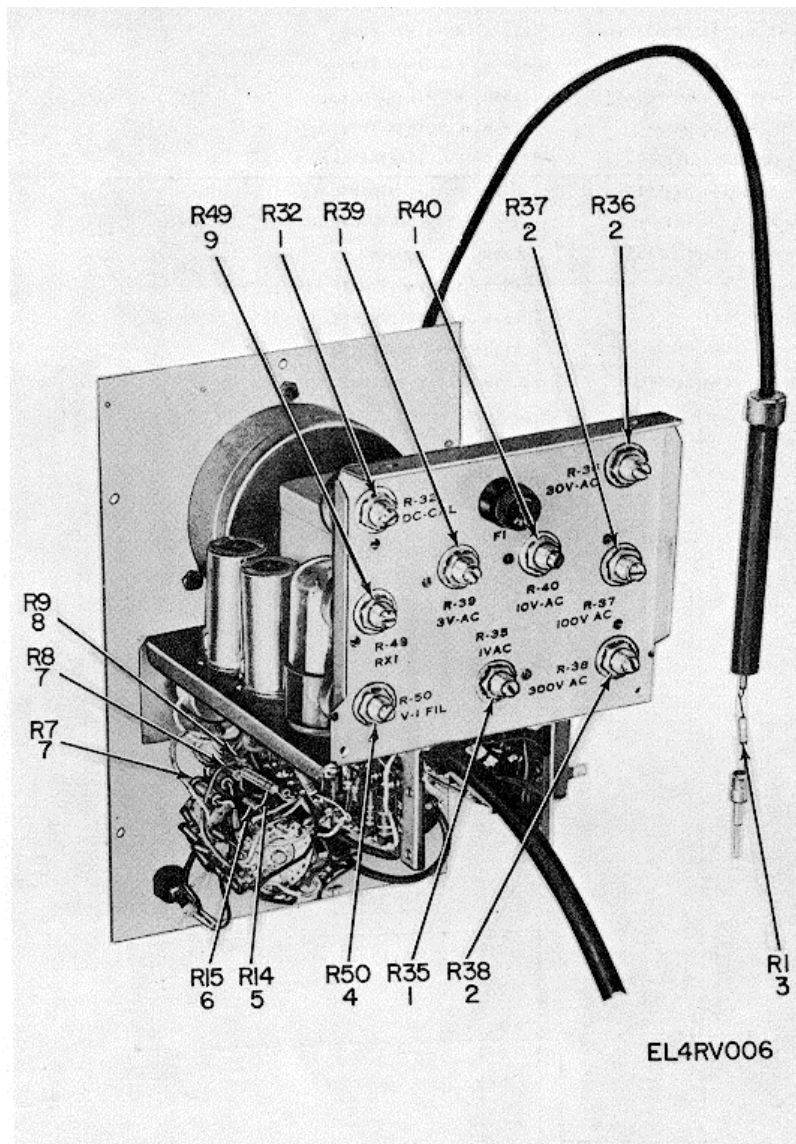

Figure 6. ME-26B, C, D/U Multimeters, Chassis, Rear View.

SECTION II

TM11-6625-200-24P

(1) ILLUSTRATION		(2)	(3)	(4)	(5)	(6) DESCRIPTION	(7)	(8)
(a) FIG NO.	(b) ITEM NO.	SMR CODE	NATIONAL STOCK NUMBER	PART NUMBER	FSCM	<i>USABLE ON CODE</i>	U/M	QTY INC IN UNIT
6	1	PAHZZ	5905-00-581-1405	RA20NASA501A	81349	RESISTOR, VAR, SEL AE3	EA	4
6	1	PAHZZ	5905-00-660-3641	RA20LASB501A	81349	RESISTOR, VARIABLE AE4, AXL	EA	4
6	2	PAHZZ	5905-00-552-0561	RA20NASA5400A	81349	RESISTOR, VAR, SELECT AE3	EA	3
6	2	PAHZZ	5905-00-702-6278	RA20LASBS00A	81349	RESISTOR, VARIABLE AE4, AXL	EA	3
6	3	XDHZZ		RC09GF226J	81349	RESISTOR, FXD, CMPSN AE3, AE4	EA	1
6	3	PAHZZ	5905-00-126-6703	RCR07G226JS	81349	RESISTOR, FXD, CMPSN AXL	EA	1
6	4	PAHZZ	5905-00-655-3414	RA20NASA6R0A	81349	RESISTOR, VAR SEL AE3	EA	1
6	4	PAHZZ	5905-00-722-1458	RA20LASB6R0A	81349	RESISTOR, VAR SEL AE4AAXL	EA	1
6	5	XDHZZ		CP1-2-684000	81349	RESISTOR, FXD, FILM AE3, AE4, AXL	EA	1
6	6	XDHZZ		CP1-2-216000	81349	RESISTOR, FXD, FILM AE3, AE4, AXL	EA	1
6	7	PAHZZ	5905-00-539-5956	DC2-21-63	00656	RESISTOR, FXD, FILM AE3.AE4, AXL	EA	2
6	8	PAHZZ	5905-00-755-0643	DC2-46-74	00656	RESISTOR, FXD, FILM AE3, AE4, AXL	EA	1
6	9	PAHZZ	5905-00-721-2632	RA20LAS8250A	81349	RESISTOR, VARIABLE AE3, AE4, AXL	EA	1

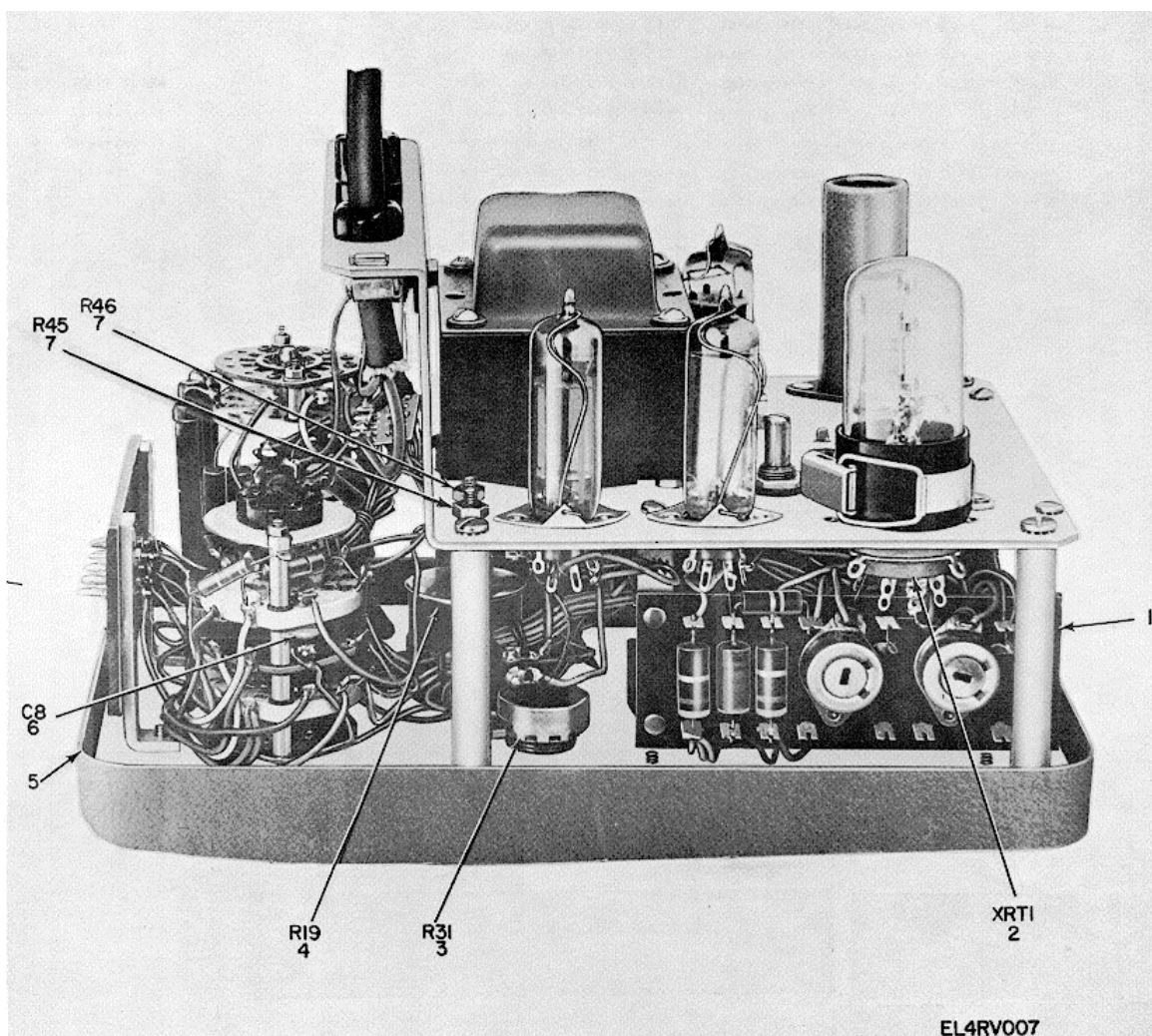

Figure 7. ME-26A/U Multimeter, Chassis, Left Side View.

SECTION II

TM11-6625-200-24P

(1) ILLUSTRATION		(2)	(3)	(4)	(5)	(6) DESCRIPTION		(7)	(8)
(a) FIG NO.	(b) ITEM NO.	SMR CODE	NATIONAL STOCK NUMBER	PART NUMBER	FSCM		<i>USABLE ON CODE</i>	U/M	QTY INC IN UNIT
7	1	PAHZZ	5330-00-821-2506	58-41-0-63	94222	PACKING, PREFORMED	AE2	EA	1
7	2	PAHZZ	5935-00-257-6870	51A12272	71785	SOCKET, ELCTRN TUBE	AE2	EA	1
7	3	PAHZZ	5905-00-853-4863	3100-0036	81349	RESISTOR, VARIABLE	AE2	EA	1
7	4	PAHZZ	5905-00-853-4862	3100-0050	28480	RESISTOR, VARIABLE	AE2	EA	1
7	5	XDHZZ		56437	08474	PACKIING, PREFORMED	AE2	EA	1
7	6	PAHZZ	5910-00-821-5215	CK60AX471K	81349	CAPACITOR, FXD, CER	AE2	EA	1
7	7	PAHZZ	5905-00-539-4231	RW30G502	81349	RESISTOR, FXD.FILM	AE2	EA	2

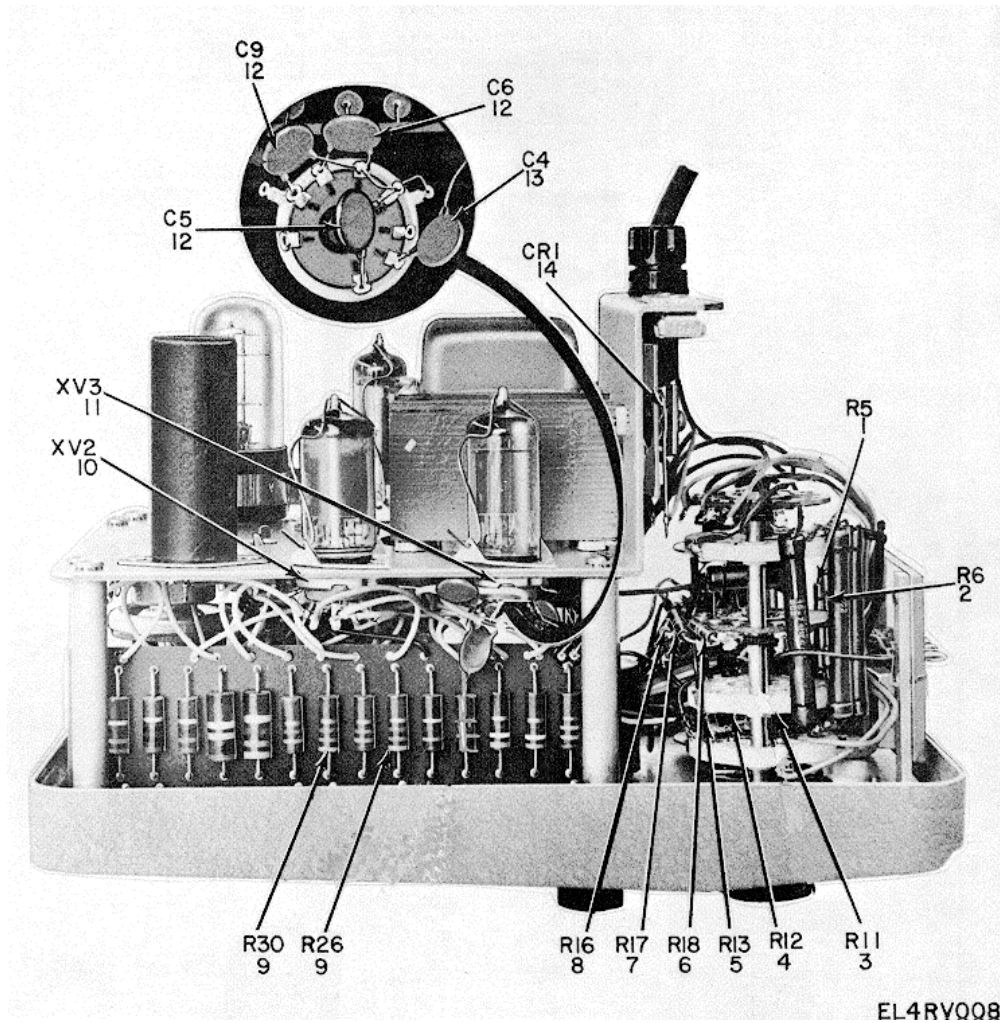

Figure 8. ME-26A/U Multimeter, Chassis, Right Side View.

SECTION II

TM11-6625-200-24P

(1) ILLUSTRATION		(2)	(3)	(4)	(5)	(6) DESCRIPTION	(7)	(8)
(a) FIG NO.	(b) ITEM NO.	SMR CODE	NATIONAL STOCK NUMBER	PART NUMBER	FSCM	<i>USABLE ON CODE</i>	U/M	QTY INC IN UNIT
8	1	PAHZZ	5905-00-526-0493	CP1-2-2-16	81349	RESISTOR, FXD.FILM AE2	EA	1
8	2	PAHZZ	5905-00-681-1077	CP1-6-84	81349	RESISTOR, FXD, FILM AE2	EA	1
8	3	XDHZZ		DC1-2C	19701	RESISTOR, FXD.FILM AE2	EA	1
8	4	PAHZZ	5905-00-681-1079	CP1-2-9000	81349	RESISTOR, FXD, FILM AE2	EA	1
8	5	PAHZZ	5905-00-988-0149	RN70D9092F	81349	RESISTOR, FXD, FILM AE2	EA	1
8	6	PAHZZ	5905-00-141-0591	RCR20G103JS	81349	RESISTOR, FXD, CMPSN AE2	EA	1
8	7	PAHZZ	5905-00-171-2004	RC20GF223J	81349	RESISTOR, FXD, CMPSN AE2	EA	1
8	8	PAHZZ	5905-00-106-9345	RCR20G683JS	81349	RESISTOR, FXD, CMPSN AE2	EA	1
8	9	PAHZZ	5905-00-195-6791	RC20GF681J	81349	RESISTOR, FXD, CHPSN AE2	EA	2
8	10	PAHZZ	5935-00-260-0516	TS102P01	81349	SOCKET, ELCTRN, TUBE AE2	EA	1
8	11	PAHZZ	5935-00-222-9828	TS1103C01	81349	SOCKET, ELCTRN, TUBE AE2	EA	1
8	12	PAHZZ	5910-00-823-1068	CK62Y472Z	81349	CAPACITOR, FXD, CER AE2	EA	3
8	13	PAHZZ	5910-00-822-5684	CK62AW332M	81349	CAPACITOR, FXD, CER AE2	EA	1
8	14	PAHZZ	6130-00-577-8470	RS30S100HS56	81349	RECTIFIER, METALLIC AE2	EA	1

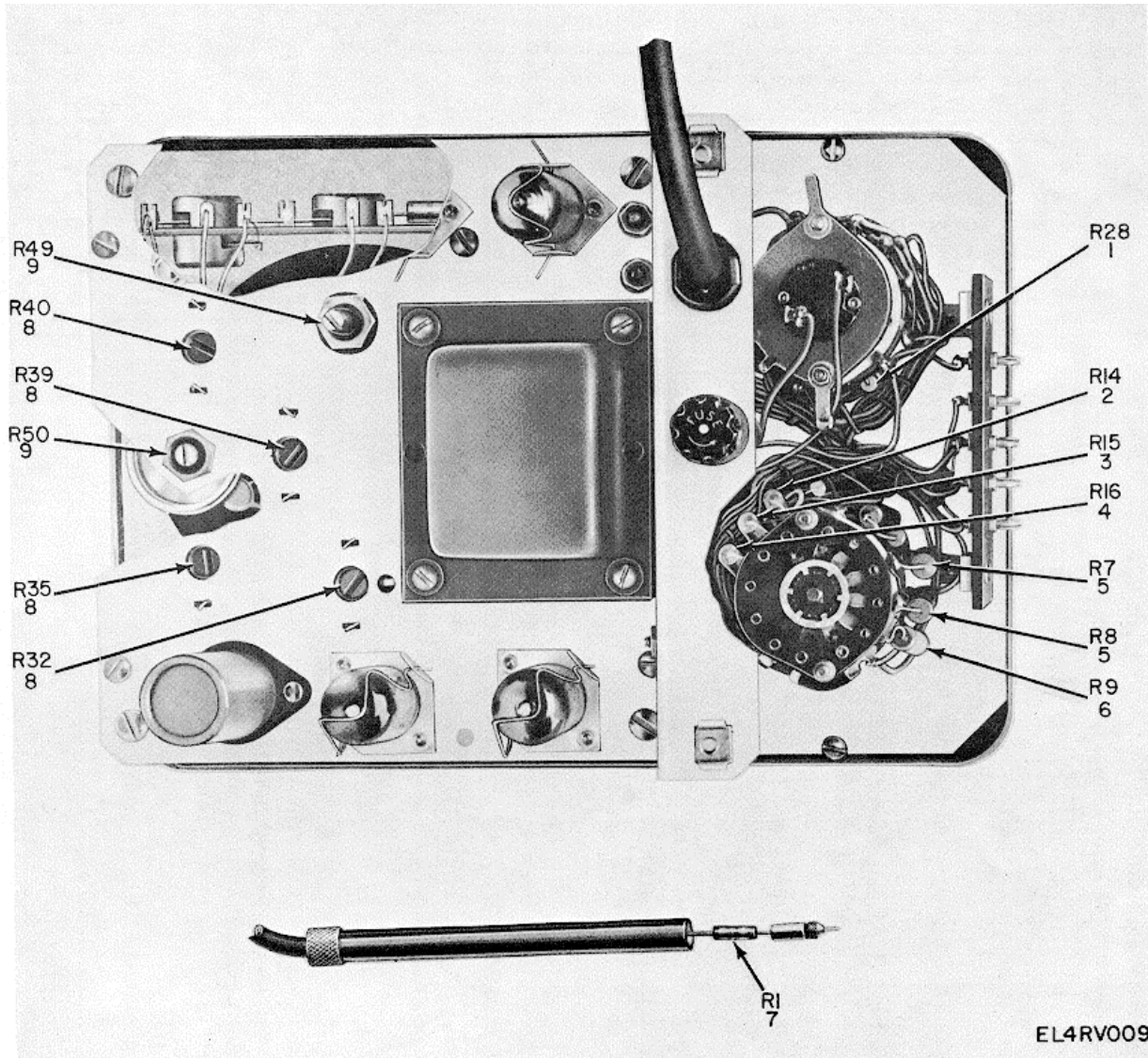

Figure 9. ME-26AU Multimeter, Alignment Resistor Locations.

SECTION II

TM11-6625-200-24P

(1) ILLUSTRATION		(2)	(3)	(4)	(5)	(6) DESCRIPTION	(7)	(8)
(a) FIG NO.	(b) ITEM NO.	SMR CODE	NATIONAL STOCK NUMBER	PART NUMBER	FSCM	<i>USABLE ON CODE</i>	U/M	QTY INC IN UNIT
9	1	PAHZZ	5905-00-279-2657	RC20GF565K	81349	RESISTOR, FXD, CMPSN AE2	EA	1
9	2	PAHZZ	5905-00-902-2887	DC128	19701	RESISTOR, FXD, FILM AE2	EA	1
9	3	XDHZZ		RN082163F	81349	RESISTOR, FXD, FILM AE2	EA	1
9	4	PAHZZ	5905-00-106-9345	RCR20G683JS	81349	RESISTOR, FXD, CMPSN AE2	EA	1
9	5	PAHZZ	5905-00-539-5956	DC2-21-63	00656	RESISTOR, FXD, FILM AE2	EA	2
9	6	PAHZZ	5905-00-755-0643	DC2-46-74	00656	RESISTOR, FXD, FILM AE2	EA	1
9	7	PAHZZ	5905-00-646-5763	RC32GF226J	81349	RESISTOR, FXD, CMPSN AE2	EA	1
9	8	PAHZZ	5905-00-951-3363	2100-0185	28480	RESISTOR, VARIABLE AE2	EA	4
9	9	PAHZZ	5905-00-913-6315	2100-0870	28480	RESISTOR, VARIABLE AE2	EA	2

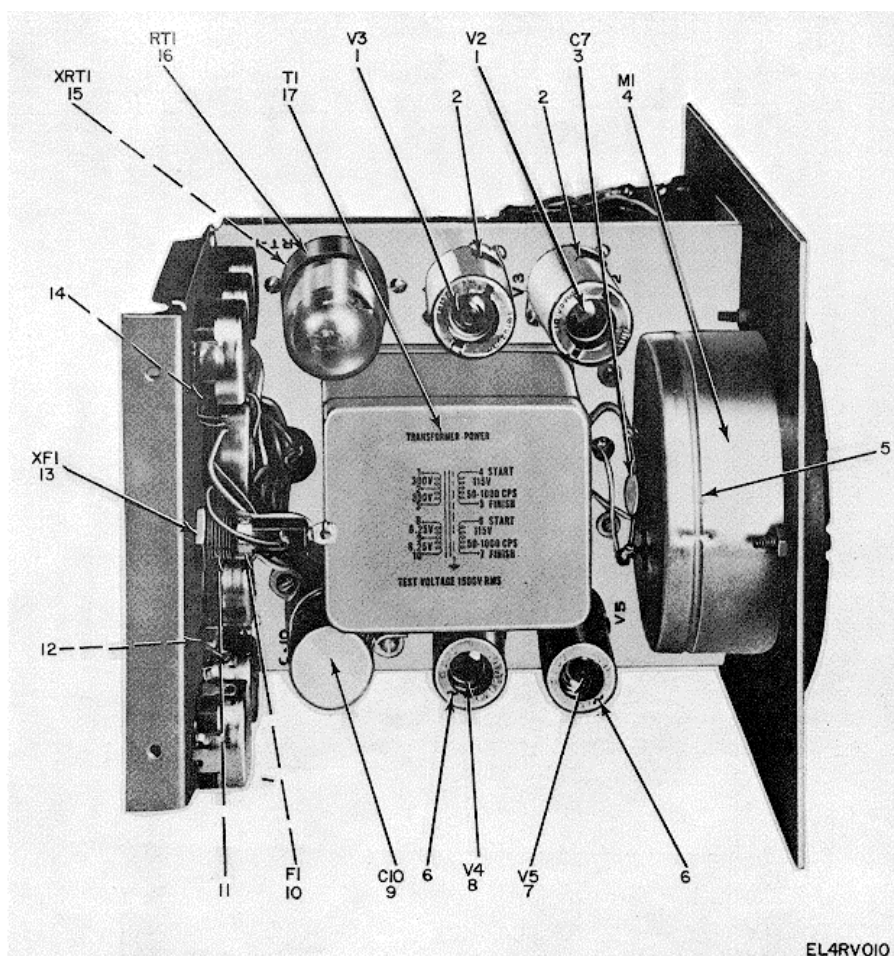

Figure 10. ME-26B, C, D/U Multimeters, Chassis, Top View.

SECTION II

TM11-6625-200-24P

(1) ILLUSTRATION		(2)	(3)	(4)	(5)	(6) DESCRIPTION		(7)	(8)
(a) FIG NO.	(b) ITEM NO.	SMR CODE	NATIONAL STOCK NUMBER	PART NUMBER	FSCM	USABLE ON CODE		U/M	QTY INC IN UNIT
10	1	PAHZZ	5960-00-636-2218	6189-12AU7	81349	ELECTRON TUBE	AE3, AE4, AXL	EA	2
10	2	PAHZZ	5960-00-729-8150	TS102U03	81349	SHIELD, ELCTR N TUBE	AE3, AE4, AXL	EA	2
10	3	PAHZZ	5910-00-823-1068	CK62Y472Z	81349	CAPACITOR, FXD, CER	AE3, AE4, AXL	EA	1
10	4	PAHZZ	6625-00-670-7580	SMC200010	80063	MULTIMETER, REPLMENT	AE3, AE4, AXL	EA	1
10	5	XDHZZ		26-015	99395	PACKING.PREFCRMED	AE3, AE4, AXL	EA	1
10	6	PAHZZ	5960-00-264-3004	TS103U02	81349	SHIELD, ELCTR N TUBE	AE3, AE4, AXL	EA	2
10	7	PAHZZ	5960-00-272-9182	6X4W4	81349	ELECTRON TUBE	AE3, AE4, AXL	EA	1
10	8	PAHZZ	5960-00-624-4718	0B2WA	81349	ELECTRON TUBE	AE3, AE4, AXL	EA	1
10	9	PAHZZ	5910-00-165-2753	CE34C150R	81349	CAPACITOR.ELCTLT	AE3, AE4, AXL	EA	1
10	10	PAOZZ	5920-00-280-9328	F02D1R508	81349	FUSE, CARTRIDGE, SEL	AE3, AE4, AXL	EA	1
10	10	PAOZZ	5920-00-284-6804	F02GR7508	81349	FUSE, CARTRIDGE.SEL	AE3, AE4, AXL	EA	1
10	11	PAOZZ	5999-00-244-5150	9435-1-2	71400	CAP, ELECTRICAL	AE3, AE4, AXL	EA	1
10	12	PAHZZ	5975-00-273-0788	6P1	28520	BUSHING, STRAIN RLF	AE3, AE4, AXL	EA	1
10	13	PAHZZ	5920-00-892-9311	FHN27U	81349	FUSEHOLDER	AE3, AE4, AXL	EA	1
10	14	PAHZZ	5975-00-889-5118	2M1	28520	BUSHING, STRAIN RLF	AE3, AE4, AXL	EA	3
10	15	PAHZZ	5935-00-257-6870	51A12272	71785	SOCKET, ELCTR N TUBE	AE3, AE4, AXL	EA	1
10	16	PAHZZ	5905-00-258-0794	6-4	70563	RESISTOR, CUR, RGLT	AE3, AE4, AXL	EA	1
10	17	PAHZZ	5950-00-681-2563	C2350	88813	TRANSFORMER, SDN-SU	AE3, AE4, AXL	EA	1

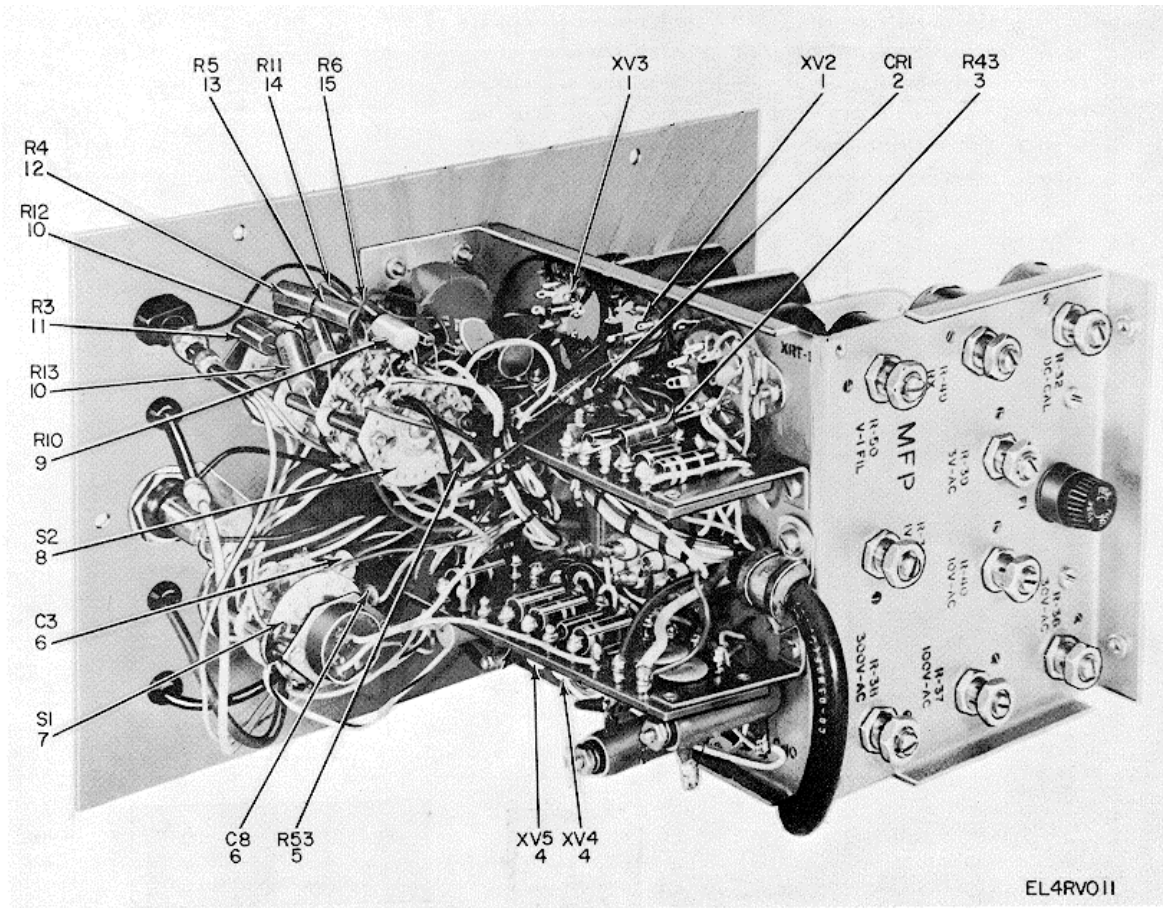

Figure 11. ME-26B, C, D/U Multimeter, Chassis, Rear View.

SECTION II

TM11-6625-200-24P

(1) ILLUSTRATION		(2)	(3)	(4)	(5)	(6) DESCRIPTION		(7)	(8)
(a) FIG NO.	(b) ITEM NO.	SMR CODE	NATIONAL STOCK NUMBER	PART NUMBER	FSCM	USABLE ON CODE		U/M	QTY INC IN UNIT
11	1	PAHZZ	5935-00-721-0124	44F16388	71785	SOCKET, ELCTR N TUBE	AE3, AE4, AXL	EA	2
11	2	PAHZZ	6130-00-548-0757	4SFLH1RV	84970	RECTIFIER, METALLIC	AE3, AE4, AXL	EA	1
11	3	PAHZZ	5905-00-106-1245	RCR32G272JS	81349	RESISTOR, FXD, CMPSN	AE3, AE4, AXL	EA	1
11	4	PAHZZ	5935-00-581-6400	111-19-21-025	71785	SOCKET, ELCTR N TUBE	AE3, AE4, AXL	EA	2
11	5	PAHZZ	5905-00-228-6088	RCR32G331JS	81349	RESISTOR, FXD, CMPSN	AE3, AE4, AXL	EA	1
11	6	PAHZZ	5910-00-722-1552	DD472	71590	CAPACITOR, FXD, CER	AE3, AE4, AXL	EA	2
11	7	XDHZZ		45643H3AC	76854	SWITCH, ROTARY	AE3, AE4, AXL	EA	1
11	8	PAHZZ	5930-00-755-0765	43852H5C	76854	SWITCH, ROTARY	AE3, AE4, AXL	EA	1
11	9	PAHZZ	5905-00-552-3893	RN7081000F	81349	RESISTOR, FXD, FILM	AE3, AE4, AXL	EA	1
11	10	PAHZZ	5905-00-902-2887	DC1-28	19701	RESISTOR, FXD, FILM	AE3, AE4, AXL	EA	2
11	11	PAHZZ	5905-00-539-5437	RN25X2163F	81349	RESISTOR, FXD, FILM	AE3, AE4, AXL	EA	1
11	12	PAHZZ	5905-00-539-4971	RN7586183F	81349	RESISTOR, FXD, FILM	AE3, AE4, AXL	EA	1
11	13	PAHZZ	5905-00-087-0560	RN70D2154F	81349	RESISTOR, FXD, FILIM	AE3, AE4, AXL	EA	1
11	14	PAHZZ	5905-00-542-9116	CPI-2-900	81349	RESISTOR, FXD, FILM	AE3, AE4, AXL	EA	1
11	15	PAHZZ	5905-00-539-5955	DCL-6-837	19701	RESISTOR, FXD, FILM	AE3, AE4, AXL	EA	1

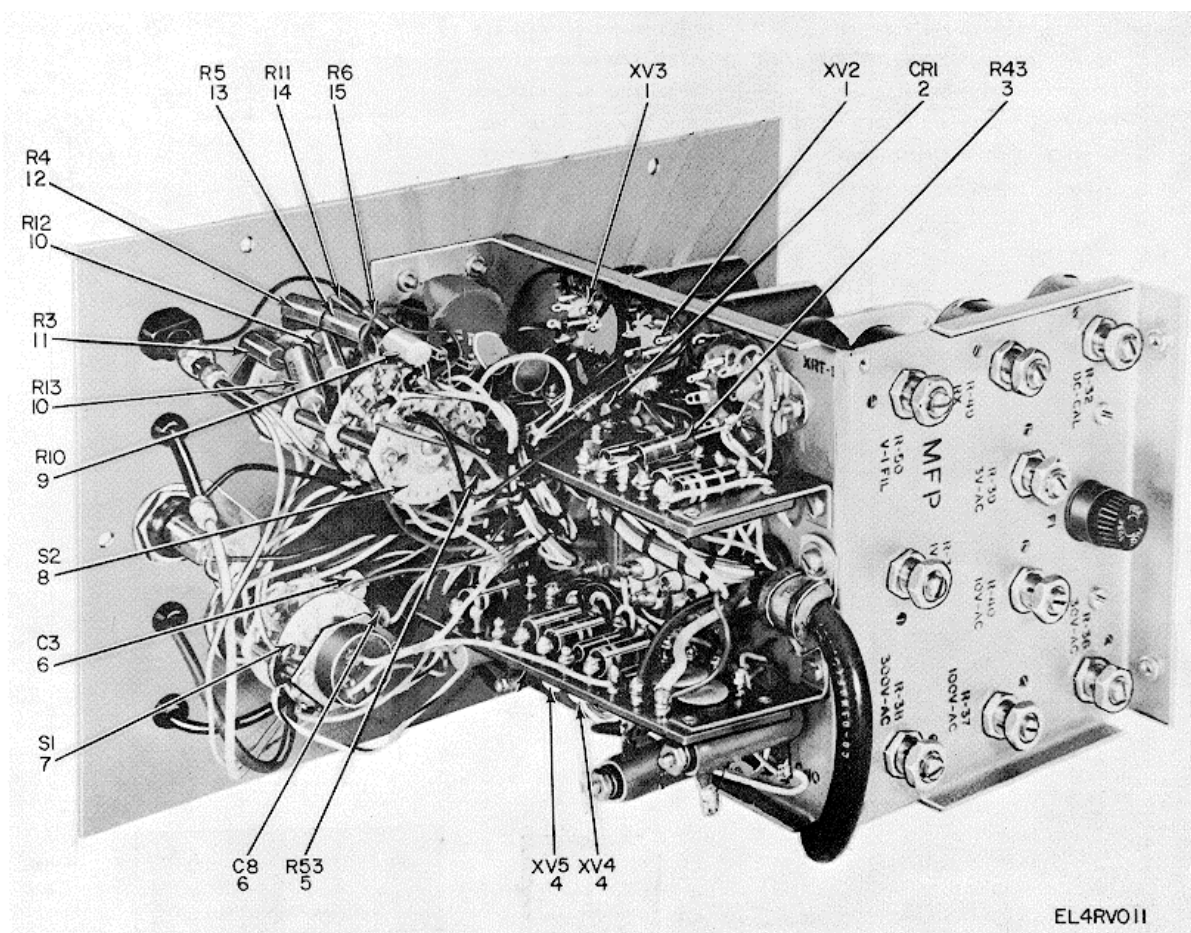
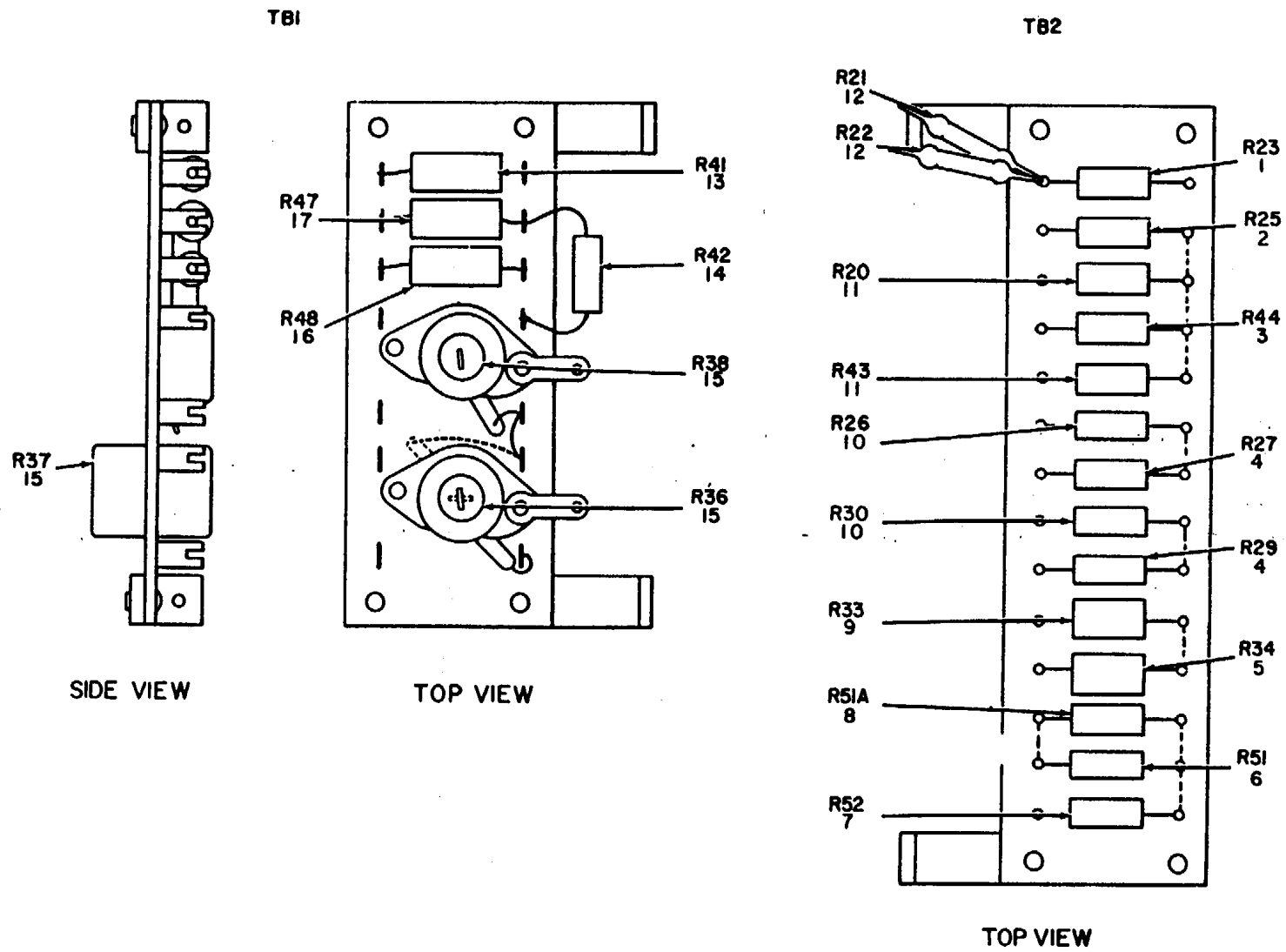

Figure 12. ME-26B, C, D/U Multimeters, Chassis, Bottom View.

SECTION II

TM11-6625-200-24P

(1) ILLUSTRATION		(2)	(3)	(4)	(5)	(6) DESCRIPTION		(7)	(8)
(a) FIG NO.	(b) ITEM NO.	SMR CODE	NATIONAL STOCK NUMBER	PART NUMBER	FSCM	USABLE ON CODE		U/M	QTY INC IN UNIT
12	1	PAHZZ	5905-00-106-1245	RCR32G272JS	81349	RESISTOR, FXD, CMPSN	AE3, AE4, AXL	EA	1
12	2	PAHZZ	5310-00-680-7669	CLA632-1	46384	NUT, PLAIN, CLINCH	AE3, AE4, AXL	EA	6
12	3	PAHZZ	5310-00-141-1815	CL632-1	24347	NUT, PLAIN, CLINCH	AE3, AE4, AXL	EA	8
12	4	PAHZZ	5340-00-282-7966	6-5-16	95987	CLAMP, LOUP	AE3, AE4, AXL	EA	1
12	5	PAHZZ	5905-00-539-4231	RW30G502	81349	RESISTOR, FXD, FILM	AE3, AE4, AXL	EA	2
12	6	PAHZZ	5935-00-222-9828	TS103C01	81349	SOCKET, ELCTR N TUBE	AE3, AE4, AXL	EA	1
12	7	PAHZZ	5935-00-935-2231	M12883-01-2	81349	SOCKET, ELCTR N TUBE	AE3, AE4, AXL	EA	1
12	8	PAHZZ	5961-00-828-9184	IN253	81349	SEMICONDUCTOR, DIODE	AE3, AE4, AXL	EA	1
12	9	PAHZZ	5905-00-578-9129	RA20NASK102A	81349	RESISTOR, VAR, SEL	AE3	EA	1
12	9	PAHZZ	5910-00-578-2551	RA20NASD102A	81349	RESISTOR, VAR, SEL	AE4, AXL	EA	1
12	10	PAHZZ	5910-00-821-5215	CK60AX471K	81349	CAPACITOR, FXD, CER	AE3, AE4, AXL	EA	1
12	11	XDHZZ		RA238AFK201A	81349	RESISTOR, VAR, SEL	AE3	EA	1
12	11	PAHZZ	5905-00-752-3834	RA20NASD201A	81349	RESISTOR, VARIABLE	AE4, AXL	EA	1
12	12	PAHZZ	5930-00-571-8675	81618	70902	SWITCH, ROTARY	AE3, AE4, AXL	EA	1
12	13	PAHZZ	5325-00-279-1235	S3448	76385	GROMMET, RUBBER	AE3, AE4, AXL	EA	1
12	14	PAHZZ	5910-00-822-5684	CK62AW332M	81349	CAPACITOR, FXD, CER	AE3, AE4, AXL	EA	1
12	15	PAHZZ	5930-00-577-8676	1617	70902	SWITCH, ROTARY	AE3, AE4, AXL	EA	1
12	16	XDHZZ		Y3986	76385	GROMMET, RUBBER	AF3, AE4, AXL	EA	1
12	17	XDHZZ		U2130	76385	GROMMET, RUBBER	AE3, AE4, AXL	EA	1
12	18	XDHZZ		CP1-2-216000	81349	RESISTOR, FXD, FILM	AE3, AE4, AXL	EA	1
12	19	XDHZZ		CP1-2-684010	81349	RESISTOR, FXD, FILM	AE3, AE4, AXL	EA	1
12	20	PAHZZ	5905-00-141-0591	RCR20G103JS	81349	RESISTOR, FXD, CMPSN	AE3, AE4, AXL	EA	1
12	21	PAHZZ	5905-00-171-2004	RC20GF223J	81349	RESISTOR, FXD, CMPSN	AE3, AE4, AXL	EA	1
12	22	PAHZZ	5905-00-617-8014	RA20NASK101A	81349	RESISTOR, VAR, SEL	AE3	EA	1
12	22	PAHZZ	5905-00-581-0449	RA20NASD010A	81349	RESISTOR, VARIABLE	AE4, AXL	EA	1



EL4RV013

Figure 13. ME-26A/U Multimeter, Terminal Boards.

SECTION II

TM11-6625-200-24P

(1)		(2)	(3)	(4)	(5)	(6)	(7)	(8)
ILLUSTRATION		DESCRIPTION	QTY					
(a)	(b)	NATIONAL	INC	PART	IN			
FIG	ITEM	SMR	STOCK	NUMBER	FSCM	USABLE ON CODE	U/M	UNIT
NO	NO	CODE	NUMBER					
13	1	PAHZZ	5905-00-454-2801	RCR32G136JS	81349	RESISTOR, FXD, CMPSN	AE2	EA 1
13	2	PAHZZ	5905-00-454-2812	RCR32G395JS	81349	RESISTOR, FXD, CMPSM	AE2	EA 1
13	3	PAHZZ	5905-00-111-8372	RCR32G222JS	81349	RESISTOR, FXD, CMPSN	AE2	EA 1
13	4	PAHZZ	5905-00-247-8722	RCR32G271JS	81349	RESISTOR, FXD, CMPSN	AE2	EA 2
13	5	PAHZZ	5905-00-185-8516	RC42GF103J	81349	RESISTOR, FXD, CMPSN	AE2	EA 1
13	6	PAHZZ	5905-00-104-8345	RCR20G560JS	81349	RESISTOR, FXD, CMPSN	AE2	EA 1
13	7	PAHZZ	5905-00-141-0720	RCR32G330JS	81349	RESISTOR, FXD, CMPSN	AE2	EA 1
13	8	PAHZZ	5905-00-454-2875	RCR32G180JS	81349	RESISTOR, FXD, CMPSN	AE2	EA 1
13	9	PAHZZ	5905-00-279-2528	RC42GF682J	81349	RESISTOR, FXD, CMPSN	AE2	EA 1
13	10	PAHZZ	5905-00-141-1071	RCR20G474JS	81349	RESISTOR, FXD, CMPSN	AE2	EA 2
13	11	PAHZZ	5905-00-279-2626	RC32GF681J	81349	RESISTOR, FXD, CMPSN	AE2	EA 2
13	12	PAHZZ	5905-00-106-1245	RCR32G272JS	81349	RESISTOR, FXD, CMPSN	AE2	EA 2
13	13	PAHZZ	5905-00-195-6449	RC42GF472K	81349	RESISTOR, FXD, CMPSN	AE2	EA 1
13	14	PAHZZ	5905-00-106-9344	RCR20G101JS	81349	RESISTOR, FXD, CMPSN	AE2	EA 1
13	15	PAHZZ	5905-00-897-9658	2100-0020	28480	RESISTOR, VARIABLE	AE2	EA 3
13	16	PAHZZ	5905-00-141-0720	RCR32G330JS	81349	RESISTOR, FXD, CMPSN	AE2	EA 1
13	17	PAHZZ	5905-00-807-7808	410B26	28480	RESISTOR, PRECISION	AE2	EA 1

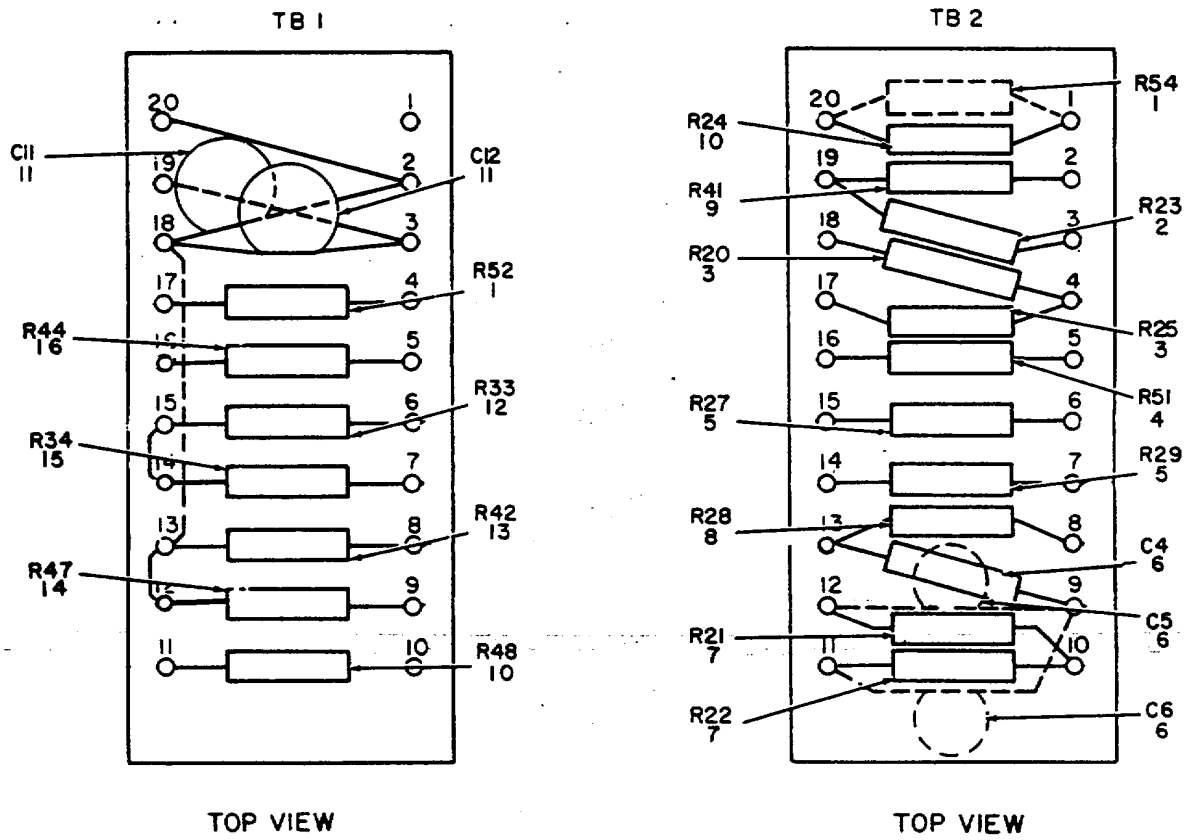

EL4RVO14

Figure 14. ME-26B, C, D/U Multimeters, Terminal Boards.

SECTION II

TM 11-662-200-24P

(1) ILLUSTRATION		(2)	(3)	(4)	(5)	(6) DESCRIPTION		(7)	(8)
(a) FIG NO.	(b) ITEM NO.	SMR CODE	NATIONAL STOCK NUMBER	PART NUMBER	FSCM		USABLE ON CODE	U/M	QTY INC IN UNIT
14	1	PAHZZ	5905-00-141-0720	RCR32G330JS	81349	RESISTOR, FXD. CMPSN	AE3,AE4,AXL	EA	2
14	2	PAHZZ	5905-00-131-9992	RCR20G136JS	81349	RESISTOR, FXD. CMPSN	AE3,AE4,AXL	EA	1
14	3	PAHZZ	5905-00-279-2510	RCR20GF395J	81349	RESISTOR, FXD, CMPSN	AE3,AE4,AXL	EA	2
14	4	PAHZZ	5905-00-104-8345	RCR20G560JS	81349	RESISTOR, FXD, CMPSN	AE3,AE4,AXL	EA	1
14	5	PAHZZ	5905-00-171-2006	RC20GF271J	81349	RESISTOR, FXD.CMPSN	AE3,AE4,AXL	EA	2
14	6	PAHZZ	5910-00-722-1552	DD472	71590	CAPACITOR, FXD, CER	AE3,AE4,AXL	EA	3
14	7	PAHZZ	5905-00-104-8347	RCR32G101JS	81349	RESISTOR. FXD, CMPSN	AE3,AE4,AXL	EA	2
14	8	PAHZZ	5905-00-279-2657	RC20GF565K	81349	RESISTOR, FXD, CMPSN	AE3,AE4,AXL	EA	1
14	9	PAHZZ	5905-00-195-6449	RC42GF472K	81349	RESISTOR, FXD, CMPSN	AE3,AE4,AXL	EA	1
14	10	PAHZZ	5905-00-219-3418	RC42GF390J	81349	RESISTOR, FXD. CMPSN	AE3,AE4,AXL	EA	2
14	11	PAHZZ	5910-00-822-5683	CK63Y103Z	81349	CAPACITOR, FXD, CER	AE3,AE4,AXL	EA	2
14	12	PAHZZ	5905-00-185-8516	RC42GF103J	61349	RESISTOR, FXD, CMPSN	AE3,AE4,AXL	EA	1
14	13	PAHZZ	5905-00-106-9344	RCR20G101JS	81349	RESISTOR, FXD, CMPSN	AE3,AE4,AXL	EA	1
14	14	PAHZZ	5905-00-807-7808	410826	28480	RESISTOR, PRECISION	AE3,AE4,AXL	EA	1
14	15	PAHZZ	5905-00-279-2528	RC42GF682J	81349	RESISTOR, FXD. CMPSN	AE3,AE4,AXL	EA	1
14	16	PAHZZ	5905-00-111-8372	RCR32G222JS	81349	RESISTOR., FXD, CMPSN	AE3,AE4,AXL	EA	1

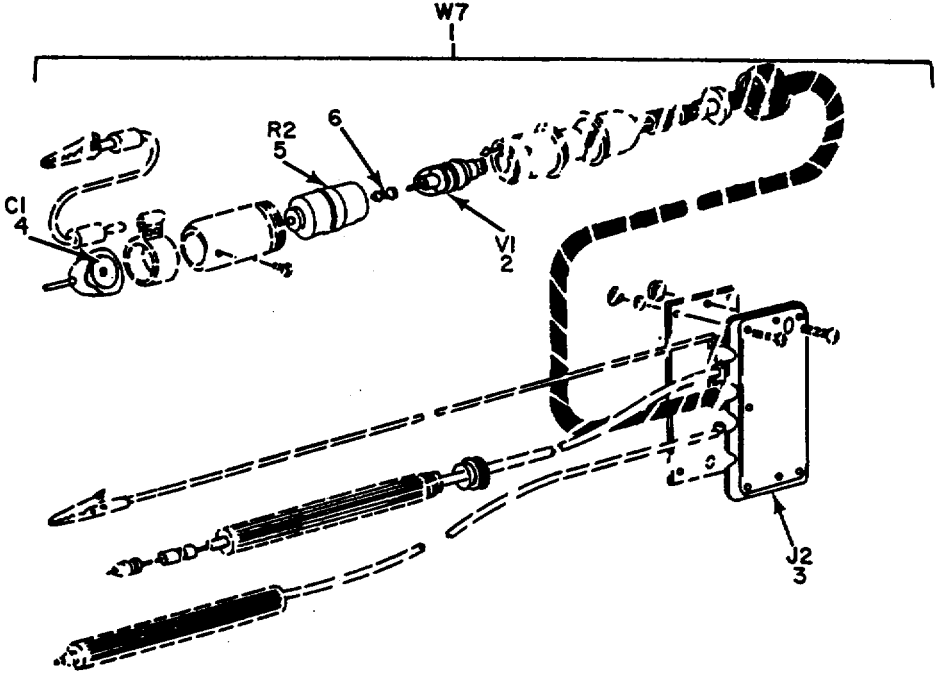

EL4RV015

Figure 15. ME-26A/U Multimeter, AC Probe Disassembled.

(1) ILLUSTRATION		(2)	(3)	(4)	(5)	(6)	(7)	(8)
(a) FIG NO.	(b) ITEM NO.	SMR CODE	NATIONAL STOCK NUMBER	PART NUMBER	FSCM	DESCRIPTION USABLE ON CODE	U/M	QTY INC IN UNIT
15	1	PAHZZ	6625-00-898-7210	SMC339386	80063	LEAD, TEST AE2	EA	1
15	2	PAHZZ	5960-00-212-6019	2-01C	24289	ELECTRON TUBE AE2	EA	1
15	3	PAHZZ	5940-00-816-8352	410B76M	72982	CONNECTOR, PLUG, ELEC AE2	EA	1
15	4	PAHZZ	5910-00-051-2217	M6TA18A007M	71590	CAPACITOR, FXD, CER AE2	EA	1
15	5	PAHZZ	5905-00-646-5763	RC32GF226J	81349	RESISTOR, FXD, CMPSN AE2	EA	1
15	6	PAHZZ	5999-00-589-5213	410B21N	28480	CONTACT, ELECTRICAL AE2	EA	1

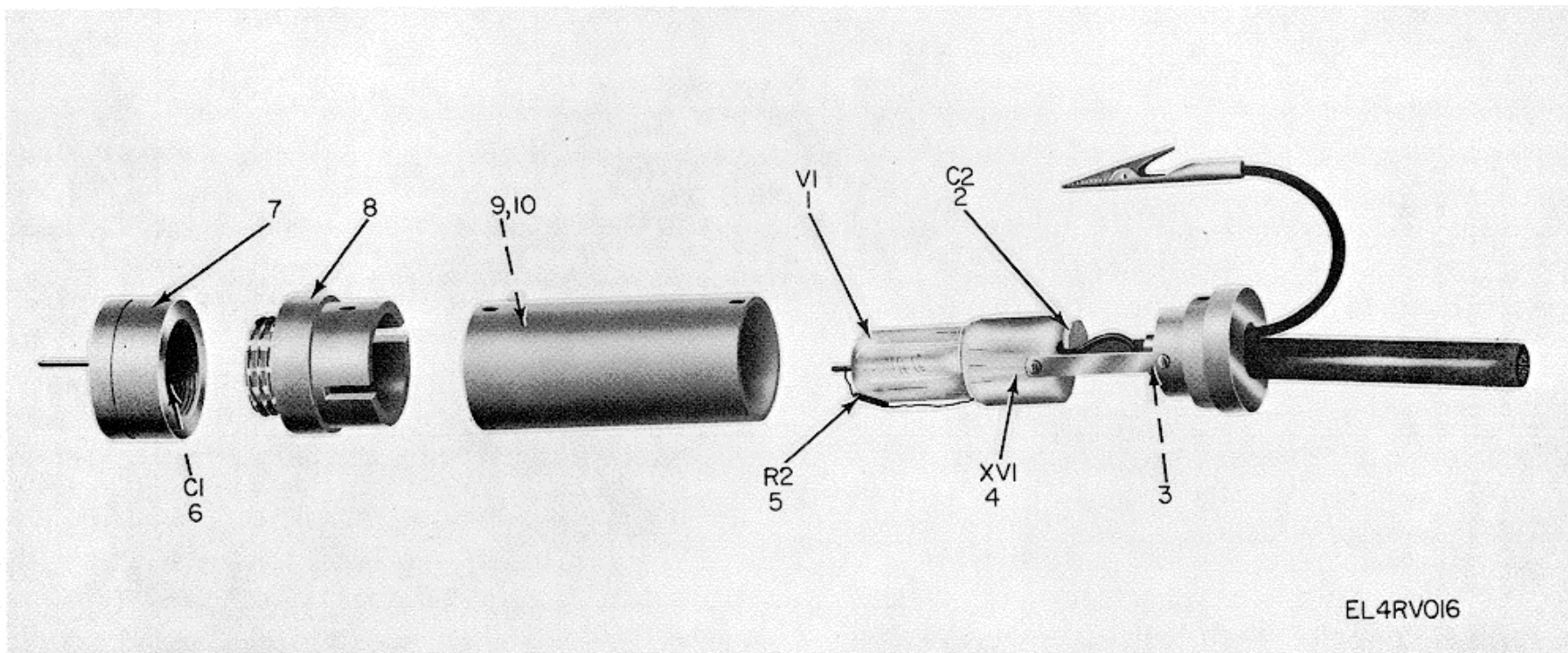

Figure 16. ME-26B, C, D/U Multimeters, AC Probe Disassembled.

SECTION II

TM11-625-200-24P

(1) ILLUSTRATION		(2)	(3)	(4)	(5)	(6) DESCRIPTION	(7)	(8)
(a) FIG NO.	(b) ITEM NO.	SMR CODE	NATIONAL STOCK NUMBER	PART NUMBER	FSCM	USABLE ON CODE	U/M	QTY INC IN UNIT
16	1	PAHZZ	5960-00-212-6019	2-01C	24289	ELECTRON TU8E	AE3,AF4,AXL	EA 1
16	2	PAHZZ	5910-00-821-5215	CK60AX471K	81349	CAPACITOR, FXD, CER	AE3,AE4,AXL	EA 1
16	3	PAHZZ	5940-00-675-586C	1855394	10001	TERMINAL, STANDOFF	AE3,AE4,AXL	EA 2
16	4	PAHZZ	5935-00-260-0516	TS102P01	81349	SOCKET. ELECTRON TUBE	AE3,AE4,AXL	EA 1
16	5	XDHZZ		RC09GF226J	81349	RESISTOR, FXD.CMPSN	AE3,AE4	EA 1
16	5	PAHZZ	5905-00-126-6703	RCR07G226J	41349	RESISTOR, FXD, CMPSN	AXL	EA 1
16	6	PAOZZ	5910-00-902-4190	658-010-242K	72182	CAPACITOR, FXD. MICA	AE3,AE4	EA 1
16	6	PAHZZ	5910-00-988-7311	M6TA18A003M	72982	CAPACITOR, FXD. TA	AXL	EA 1
16	7	PAOZZ	6625-00-898-7240	SMB339387	80063	PLUG, TIP	AE3,AE4,AXL	EA 1
16	8	PAHZZ	6625-00-087-6820	SMB339390	80063	PROBE, BAND	AE3,AE4,AXL	EA 1
16	9	PAHZZ	59700-0-087-2334	SMB339391	80063	INSULATOR, SLEEVE	AE3,AE4,AXL	EA 1
16	10	PAHZZ	5975-00-503-1440	62	76545	INSULATOR	AE3,AE4,AXL	EA 1

NATIONAL STOCK NUMBER AND PART NUMBER INDEX

NOTE: LATEST NATIONAL STOCK NUMBER AND PART NUMBER ASSIGNMENTS ARE INCLUDED AT END OF INDEX

STOCK NUMBER	FIG. NO.	ITEM NO.	STOCK NUMBER	FIG. NO.	ITEM NO.
5910-00-051-2217	15	4	5920-00-503-2882	5	11
6625-00-068-1739	1	6	5920-00-504-8634	5	11
			5905-00-526-0493	8	1
5905-00-087-0560	11	13	5905-00-539-4231	7	7
5970-00-087-2334	16	9	5905-00-539-4231	12	5
6625-00-087-6820	16	8	5905-00-539-4971	11	12
5905-00-104-8345	13	6	5905-00-539-5437	11	11
5905-00-104-8345	14	4	5905-00-539-5955	11	15
5905-00-106-9344	13	14	5905-00-539-5556	6	7
5905-00-106-9344	14	13	5905-00-539-5956	9	5
5905-00-111-8372	13	3	5905-00-542-9116	11	14
5905-00-111-8372	14	16	5355-00-543-0789	4	1
5905-00-141-0720	13	7	5355-00-547-7996	3	5
5310-00-141-1815	12	3	6130-00-548-0757	11	2
6240-00-155-8706	3	2	5905-00-552-0561	6	2
5910-00-165-2753	10	9	5905-00-552-3893	11	9
5905-00-171-2004	8	7	5355-00-556-0145	4	2
5905-00-171-2004	12	21	6130-00-577-8470	8	14
5905-00-171-2006	14	5	5930-00-577-8675	12	12
5325-00-171-4680	2	14	5930-00-577-8676	12	15
5905-00-185-8516	13	5	5905-00-578-2551	12	9
			5905-00-578-9129	12	9
			5905-00-581-0449	12	22
6210-00-185-8779	3	3	5905-00-581-1405	6	1
5905-00-195-6449	13	13	6145-00-583-9268	2	3
5905-00-195-6449	14	9	5999-00-589-5213	15	6
5999-00-204-5206	2	4	6625-00-618-1766	2	5
5960-00-212-6019	15	2	5960-00-624-4718	5	8
5935-00-222-9828	8	11	5960-00-624-4718	10	8
5935-00-222-9828	12	6	6145-00-635-9338	1	2
5905-00-228-6088	11	5	5960-00-636-2218	5	1
6145-00-229-9862	2	7	5960-00-636-2218	10	1
5999-00-244-5150	5	12	5935-00-636-7145	1	10
5999-00-244-5150	10	11	5535-00-636-7145	2	9
5905-00-247-8722	13	4	5905-00-646-5763	9	7
			5905-00-646-5763	15	5
			6625-00-649-4958	5	4
6145-00-249-6781	2	8	5905-00-655-3414	6	4
5935-00-257-6870	7	2	5905-00-660-3641	6	1
5935-00-257-6870	10	15	6625-00-670-7580	10	4
5905-00-258-0794	5	6	5940-00-675-5860	16	3
5905-00-258-0794	10	16	5905-00-681-1077	8	2
5935-C0-260-0516	8	10	5905-00-681-1079	8	4
5935-C0-260-0516	16	4	5950-00-681-2563	10	17
5960-00-264-3004	10	6	5905-00-702-6278	6	2
5960-00-272-9182	5	10	5960-00-715-0790	5	7
5960-00-272-9182	10	7	5935-00-721-0124	11	1
5975-00-273-0788	5	14	5905-00-721-2632	6	9
5975-00-273-0788	10	12	5355-00-721-8924	3	7
5325-00-275-4480	2	13	5905-00-722-1458	6	4
5325-00-279-1235	12	13	5960-00-729-8150	10	2
			5905-00-752-3834	12	11
5905-00-279-2295	14	15	5905-00-755-0643	6	8
5905-00-279-2510	14	3	5905-00-755-0643	9	6
			5930-00-755-0765	11	8
5905-00-279-2626	13	11	5355-00-801-0470	3	4
			5355-C0-803-4286	3	6
			5905-00-807-7808	13	17
			5905-00-807-7808	14	14
5905-00-279-2657	9	1	5910-00-816-4176	5	3
5905-00-279-2657	14	8	5940-00-816-8352	15	3
5905-00-279-3418	14	10	6625-00-821-2307	1	5
			5330-00-821-2506	7	1
			5910-00-821-5215	7	6
			5910-00-821-5215	12	10
5920-00-280-9328	10	10	5910-00-821-5215	16	2
5340-00-282-7966	12	4	5910-00-822-5683	14	11
6145-00-284-0579	1	11	5910-00-822-5684	8	13
6145-00-284-0579	2	11	5910-00-822-5684	12	14
5920-00-284-6804	10	10	5910-00-823-1068	8	12
5960-00-284-6893	5	17	5910-00-823-1068	10	3
5325-00-285-2012	2	1	6625-00-825-6704	1	7
			5961-00-828-9184	12	8
6210-00-299-4099	3	1			
621C-00-299-4099	4	3			
6625-00-302-4909	1	8	5340-00-844-3170	5	9
6625-00-331-1471	2	6	5935-00-845-1376	5	5
5905-00-454-2801	13	1	6250-00-845-8390	2	10
5905-00-454-2875	13	8	5340-00-846-8451	1	9
5975-00-503-1440	16	10	5340-00-846-8451	2	12

SECTION IV

TM11-6625-200-24P

NATIONAL STOCK NUMBER AND PART NUMBER INDEX

STOCK NUMBER		FIG. NO.	ITEM NO.	STOCK NUMBER		FIG. NO.	ITEM NO.
5325-00-846-8452		5	15	6625-00-898-7270		2	2
5905-00-853-4862		7	4	6625-00-898-7270		15	1
5905-00-853-4863		7	3	5905-00-902-2887		9	2
5975-00-889-5118		10	14	5905-00-902-2887		11	10
5920-00-892-9311		5	13	5910-00-902-4190		16	6
5920-00-892-9311		10	13	5935-00-935-2231		12	7
5905-00-897-9658		13	15	5950-00-950-0524		5	16
6625-00-898-7240		16	7	5905-00-951-3363		9	8
6625-00-898-7270		1	3	5910-00-988-7311		16	6

PART NUMBER	FSCM	FIG. NO.	ITEM NO.	PART NUMBER	FSCM	FIG. NO.	ITEM NO.
A3-25	72794	2	1	RA20NASD201A	81349	12	11
				RC09GF226J	81349	6	3
81618	70902	12	12	RC09GF226J	81349	16	5
81619	70902	2	5				
CE34C150R	81349	10	9				
CK60AX471K	81349	7	6				
CK60AX471K	81349	12	10				
CK60AX471K	81349	16	2				
CK62AW332M	81349	8	13	RC20GF223J	81349	8	7
CK62AW332M	81349	12	14	RC20GF223J	81349	12	21
CK62Y472Z	81349	8	12	RC20GF271J	81349	14	5
CK62Y472Z	81349	10	3	RC20GF395J	81349	14	3
CK63Y103Z	81349	14	11				
CLA632-1	46384	12	2	RC20GF565K	81349	9	1
CL632-1	24347	12	3	RC20GF565K	81349	14	8
CP1-2-2-16	81349	8	1	RC20GF681J	81349	8	9
CP1-2-216000	81349	6	6				
CP1-2-216000	81349	12	18				
CP1-2-684000	81349	6	5				
CP1-2-684000	81349	12	19				
CP1-2-900	81349	11	14				
CP1-2-9000	81349	8	4				
CP1-6-84	81349	8	2				
C003MGF3-18-0330	81349	1	11				
C003MGF3-18-0330	81349	2	11	RC32GF226J	81349	9	7
C2350	88813	10	17	RC32GF226J	81349	15	5
OCI-28	19101	9	2				
OCI-28	19701	11	10				
OC1-2C	19701	8	3				
OCI-6-837	19701	11	15				
CC2-21-63	00656	6	7				
OC2-21-63	00656	9	5	RC32GF68IJ	81349	13	11
DC2-46-74	00656	6	8	RC42GF103	81349	13	5
OC2-46-74	00656	9	6				
028434	56289	5	3				
FHN27U	81349	5	13				
FHN27U	81349	10	13				
FO201R508	81349	10	10	RC42GF472K	81349	13	13
FO2GR7508	81349	10	10	RC42GF472K	81349	14	9
GA3-200	72794	2	13				
G74AC	28480	3	4				
G74C	28480	3	7	RG122U	81349	2	3
G74J	28480	3	6	RN25X2163F	81349	11	11
G74N	28480	3	5	RN70B1000F	81349	11	9
LH50R2	81349	4	4	RN7082163F	81349	9	3
N591528-IK20	96906	4	2	RN7586183F	81349	11	12
NS91528-1N2D	96906	4	1	RS30S100H5S56	81349	8	14
M6TA18A003M	72982	16	6				
M6TA11AC07M	71590	15	4				
RA20AFK201A	81349	12	11	SMB339387	80063	16	7
RA20LAS8250A	81349	6	9	SMB339390	80063	16	8
RAO2LASB500A	81349	6	2	SMB339391	80063	16	9
RA20LASBS01A	81349	6	1	SMC200010	80063	10	4
RA2OLAS86R0A	81349	6	4	SMC339386	80063	15	1
				S3-175	72794	2	14
RA20NAFK102A	81349	12	9	S3448	76385	12	13
RA20NASA500A	81349	6	2				
RA2ONASAS01A	81349	6	1	TS102P01	81349	8	10
RA20NASA6ROA	81349	6	4	TS102P01	81349	16	4
RA20NASOIOIA	81349	12	22	TS102U03	81349	10	2
				TS103C01	81349	8	11

PART NUMBER	FSCM	FIG. NO.	ITEM NO.	PART NUMBER	FSCM	FIG. NO.	ITEM NO.
TS103C01	81349	12	6	410821K	28480	5	5
TS103U02	81349	10	6	410821N	28480	15	6
UPI21M	81349	1	10	410826	28480	13	17
UPI21M	81349	2	9	410826	28480	14	14
U2130	76385	12	17	410876M	72982	15	3
Y3986	76385	12	16	43852H5C	76854	11	8
082WA	81349	5	8	44F16388	71785	11	1
O82WA	81349	10	8	45643H3AC	76854	11	7
0403-0004	28480	1	9	47	24446	3	2
0403-0004	28480	2	12	500	01538	5	15
1N253	81349	12	8	51A12272	71785	7	2
1120-0009	28480	5	4	51A12272	71785	10	11
120D5-63AHS	91506	5	7	56437	08474	7	5
1400-0005	28480	5	17	58-41-0-63	94222	7	1
1400-0039	28480	5	9	6-4	70563	5	6
1440-0002.	00837	1	1	6-4	70563	10	16
1617	70902	12	15	6-5-16	95987	12	4
1855394	10001	16	3	6P1	28520	5	14
2M1	28520	10	14	6P1	28520	10	12
2100-0020	28480	13	15	6X4WA	81349	5	10
				6X4W4	81349	10	7
2100-0185	28480	9	8	60	76545	2	4
				6109-12AU7	81349	5	1
				6189-12AU7	81349	10	1
26-015	99395	10	5	62	76545	16	11
3100-0036	81349	7	3	658-010-242K	72982	16	6
31C0-0050	28480	7	4	6580202Y2K	72982	1	4
313-250	75915	5	11	81-121	72619	3	3
313-400	75915	5	11	81081	72619	3	1
				81081	72619	4	3
319	83330	2	6	81246	72619	2	11
4SFIHIRV	84970	11	2	8410	70903	1	2
410821-95A	28480	1	8	8899BLACK	70903	2	7
				8899RE0	70903	2	8
410821-95C	28480	1	6	9100-0021	28480	5	16
410821-95D	28480	1	5	9435-1-2	71400	5	12
410821-95t	28480	1	7	9435-1-2	71400	10	11

LATEST NATIONAL STOCK NUMBER ASSIGNMENTS

STOCK NUMBER	FIG. NO.	ITEM NO.	STOCK NUMBER	FIG. NO.	ITEM NO.
5905-00-131-9992	14	2	5310-00-680-7669	12	2
5905-00-185-8516	14	12	5910-00-722-1552	5	2
5905-00-195-6791	8	9	5910-00-722-1552	11	6
5960-00-212-6019	16	1	5910-00-722-1552	14	6
5905-00-617-8014	12	22			

LATEST PART NUMBER ASSIGNMENTS

PART NUMBER	FSCM	FIG. NO.	ITEM NO.	PART NUMBER	FSCM	FIG. NO.	ITEM NO.
DD472	71590	5	2	RC20GF136JS	81349	14	2
DD472	71590	11	6	RC42GF103J	81349	14	12
DD472	71590	14	6	2-01C	24289	16	1
RA20NASK101A	81349	12	22				

ADDITIONAL LATEST NATIONAL STOCK NUMBER ASSIGNMENTS

STOCK NUMBER	FIG. NO.	ITEM NO.	STOCK NUMBER	FIG. NO.	ITEM NO.
5905-00-104-8347	14	7	5905-00-141-0720	13	16
5905-00-106-1245	11	3	5905-00-141-0720	14	1
5905-00-106-1245	12	1	5905-00-141-1071	13	10
5905-00-106-1245	13	12	5905-00-279-2528	13	9
5905-00-106-9345	8	8	5905-00-279-2528	14	15
5905-00-106-9345	9	4	5905-00-454-2812	13	2
5905-00-126-6703	6	3	5935-00-581-6400	11	4
5905-00-126-6703	16	5	5960-00-729-8150	10	2
5905-00-141-4091	8	6	5905-00-913-6315	9	9
5905-00-141-05 91	12	20	5905-00-988-0149	8	5

ADDITIONAL LATEST PART NUMBER ASSIGNMENTS

PART NUMBER	FSCM	FIG. NO.	ITEM NO.	PART NUMBER	FSCM	FIG. NO.	ITEM NO.
M12883-01-2	81349	12	7	RCR32G272JS	81349	12	1
RA20NASK102A	81349	12	9	RCR32G272JS	81349	13	2
RCR07G226JS	81349	6	3	RCR32G330JS	81349	13	7
RCR07G226JS	81349	16	5	RCR32G330JS	81349	13	16
RCR20G101JS	81349	13	14	RCR32G330JS	81349	14	1
RCR20G101JS	81349	14	13	RCR32G331JS	81349	11	5
RCR20G103JS	81349	8	6	RCR32G395JS	81349	13	2
RCR20G103JS	81349	12	20	RC42GF390J	81349	14	10
RCR20G474JS	81349	13	10	RC42GF682J	81349	13	9
RCR20G560JS	81349	13	6	RC42GF682J	81349	14	15
RCR20G560JS	81349	14	4	RN70D2154F	81349	11	13
RCR20G683JS	81349	8	8	RN70D9092F	81349	8	5
RCR20G683JS	81349	9	4	RW30G502	81349	7	7
RCR32G101JS	81349	14	7	RW30G502	81349	12	5
RCR32G136JS	81349	13	1	SMC339386	81349	1	3
RCR32G180JS	81349	13	8	SMC339386	81349	2	2
RCR32G222JS	81349	13	3	111-19-21-025	71785	11	4
RCR32G222JS	81349	14	16	2-01C	24289	15	2
RCR32G271JS	81349	13	4	2100-0870	28480	9	9
RCR32G272JS	81349	11	3				

39/(40 BLANK)

By Order of the Secretary of the Army:

BERNARD W. ROGERS
General, United States Army
Chief of Staff

Official:

J. C. PENNINGTON
Brigadier General, United States Army
The Adjutant General

DISTRIBUTION:	6-186	29-36
Active Army	6-200	29-37
USAINSCOM (2)	6-201	29-51
COE (1)	6-300	29-55
TSG (1)	6-302	29-56
USAARENBD (1)	6-365	29-57
DARCOM (1)	6-366	29-75
TRADOC (2)	6-425	29-79
OS Maj Comd (4)	6-426	29-102
TECOM (2)	6-435	29-105
USACC (4)	6-436	29-109
MDW (1)	6-455	29-134
Armies (2)	6-456	29-139
Corps (2)	6-575	29-245
USMA (2)	6-576	29-247
Svc Colleges (1)	6-577	29-427
USASIGS (5)	6-615	30-34
USAADS (2)	6-616	31-105
USAFAS (2)	7	32-57
USAARMS (2)	7-100	32-87
USAIS (2)	7-157	32-97
USAES (2)	11-15	32-500
USAICS (3)	11-16	37
MAAG (1)	11-17	37-100
USARMIS (1)	11-19	39-401
USAERDAA (1)	11-35	44-2
USAERDAW (1)	11-37	44-8
USACC-EUR (2)	11-38	44-12
Fort Gillem (10)	11-39	44-236
Fort Gordon (10)	11-117	44-255
Fort Huachuca (10)	11-127	44-256
Fort Carson (5)	11-137	44-535
Ft Monmouth (HISA) (33)	11-215	44-536
Ft Richardson (CERCOM) (2)	11-216	44-537
Army Dep (1) except	11-225	44-545
LBAD (14)	11-226	44-546
SAAD (30)	11-327	44-547
TOAD (14)	11-347	55-89
SHAD (3)	11-357	55-99
USA Dep (1)	11-367	55-157
Sig Sec USA Dep (1)	11-368	55-457
Units org under fol TOE:	11-377	55-458
(1 cy each unit) UNOINDC	11-500 (AA-AC)	57
1-128	17	57-100
1-207	7-100	57-102
6-100	29-1	67
6-115	29-11	77-100
6-116	29-15	77-102
6-155	29-16	29-207 (2)
6-156	29-17	29-610 (2)
6-165	29-21	
6-166	29-25	
6-175	29-26	
6-176	29-27	
6-185	29-35	

NG: State AG (3); Units-Same as Active Army
 USAR: None
 For explanation of abbreviations used, see AR 310-50.

RECOMMENDED CHANGES TO EQUIPMENT TECHNICAL PUBLICATIONS



THEN... JOT DOWN THE DOPE ABOUT IT ON THIS FORM, CAREFULLY TEAR IT OUT, FOLD IT AND DROP IT IN THE MAIL!

SOMETHING WRONG WITH THIS PUBLICATION?

FROM: (PRINT YOUR UNIT'S COMPLETE ADDRESS)

DATE SENT

PUBLICATION NUMBER

PUBLICATION DATE

PUBLICATION TITLE

BE EXACT... PIN-POINT WHERE IT IS

PAGE NO.

PARA-GRAPH

FIGURE NO.

TABLE NO.

IN THIS SPACE TELL WHAT IS WRONG AND WHAT SHOULD BE DONE ABOUT IT:

TEAR ALONG PERFORATED LINE

PRINTED NAME, GRADE OR TITLE, AND TELEPHONE NUMBER

SIGN HERE:

DA FORM 2028-2
1 JUL 79

PREVIOUS EDITIONS
• ARE OBSOLETE.

P.S.—IF YOUR OUTFIT WANTS TO KNOW ABOUT YOUR RECOMMENDATION MAKE A CARBON COPY OF THIS AND GIVE IT TO YOUR HEADQUARTERS.

